



2026

# ZÁHRADA

**T.TAKÁCS**

**Florcom**<sup>®</sup>

 **ICL**

**Modiform**<sup>®</sup>  

**Orgánica**<sup>®</sup>  
de sustratos 

**floser**<sup>®</sup>  

**KLASMANN**  **DEILMANN**  
*we make it grow*

**ipp**  
INTERPLAST PLASTIC PRODUCTS

**terra**  **san**<sup>®</sup>

 **Prosperplast**<sup>®</sup>



**Bradas**<sup>®</sup>

**B**  **O PON**

**fitt** 

 **JUTA**

**FELCO**  
SWISS  MADE

**FISKARS**<sup>®</sup>

 **BARENBRUG**

 **DLF**  
SEEDS & SCIENCE 

# OBSAH

<b>SUBSTRÁTY, RAŠELINA, KÔRA</b>	<b>2-17</b>
<b>HNOJIVÁ</b>	<b>18-35</b>
<b>OSIVÁ</b>	<b>36-39</b>
<b>PRÍSLUŠENSTVO K TRÁVNIKOM</b>	<b>40-43</b>
<b>KVETINÁČE, MULTIPLATÁ</b>	<b>44-59</b>
<b>CHÉMIA</b>	<b>60-68</b>
<b>OCHRANA PRED ŠKODCAMI</b>	<b>69-79</b>
<b>BAZÉNOVÁ CHÉMIA A PRÍSLUŠENSTVO</b>	<b>80-85</b>
<b>TEXTÍLIE</b>	<b>86-87</b>
<b>ZÁHRADKÁRSKE POTREBY</b>	<b>88-122</b>
<b>ZÁHRADNÉ OSVETLENIE</b>	<b>123-141</b>
<b>KAMENE</b>	<b>142-156</b>

Firma si vyhradzuje právo na zmenu produktov.

Aktuálne produkty nájdete aj  
v objednávkovom systéme:

[www.takacs.sk](http://www.takacs.sk)



**ZÁHRADNÍCKY SUBSTRÁT**

Univerzálny substrát s širokými možnosťami použitia na pestovanie kvetín, zeleniny, drevín a vylepšenia pôdy na záhonoch. Substrát je vyrobený z kvalitnej vrchoviskovej rašeliny, kompostovanej kôry a prírodného humusu. Je obohatený živinami, vyznačuje sa trvalo stabilnou štruktúrou.



Kód	balenie	pal.
<b>2200</b>	10 l	238
<b>2300</b>	20 l	132
<b>2350</b>	50 l	51
<b>2400</b>	75 l	39



**BALKÓNOVÉ KVETY**

Špeciálny substrát pre balkónové rastliny, najmä pre pelargónie, ktoré sú náročné na živiny. Substrát je vyrobený z kvalitnej vrchoviskovej rašeliny, kompostovanej kôry, prírodného humusu a čistého ílu. Je výdatne obohatený živinami a stopovými prvkami, vyznačuje sa trvalo stabilnou štruktúrou, ktorá zaručuje optimálne prevzdušnenie a vododržnosť. Vďaka svojim vlastnostiam zaručuje veľký nárast a bohaté kvitnutie všetkých balkónových rastlín vrátane muškátov.



Kód	balenie	pal.
<b>600</b>	10 l	238
<b>700</b>	20 l	132
<b>800</b>	50 l	51
<b>900</b>	75 l	39



**IZBOVÉ RASTLINY**

Substrát určený na pestovanie väčšiny izbových rastlín okrasných kvetom aj listom. Substrát je vyrobený z kvalitnej vrchoviskovej rašeliny, kompostovanej kôry a prírodného humusu. Je obohatený živinami a vyznačuje sa trvalo stabilnou štruktúrou, vytvára priaznivé podmienky pre rast a zdravý vývoj izbových rastlín.



Kód	balenie	pal.
<b>100</b>	5 l	270
<b>200</b>	10 l	238
<b>300</b>	20 l	132



**VÝSEVNÝ**

Substrát je určený na výsevy semien kvetín a zeleniny. Ďalej slúži na množenie kvetín a drevín odrezkami. Substrát je vyrobený z jemných triedených rašielín s prídavkom kremičitého piesku a humusu.



Kód	balenie	pal.
<b>1600</b>	10 l	238
<b>1700</b>	20 l	132



**FARMÁRSKY**

Substrát je určený na ekologické pestovanie, do vyvýšených záhonov bez použitia minerálnych hnojív.



Kód	balenie	pal.
<b>2420</b>	50 l	51



### OKRASNÉ DREVINY

Špeciálny substrát určený na vysádzanie a pestovanie ihličnatých aj listnatých kríkov a stromov. Substrát je vyrobený z kvalitnej kyslej vrchoviskovej rašeliny, kompostovanej kôry a prírodného humusu. Je obohatený o živiny a stopové prvky.



Kód	balenie	pal.
<b>2105</b>	50 l	51
<b>2100</b>	75 l	39



### RAŠELINA

Kvalitná vrchovisková biela rašelina, vhodná na obohatenie pôdy o organické látky, okyslenie alkalických pôd a výrazné zlepšenie chemických a fyzikálnych vlastností pôd. Rašelina je čistý organický produkt, nemá upravené pH a nemá pridané živiny.



Kód	balenie	pal.
<b>5100</b>	20 l	132
<b>5200</b>	75 l	39



### TRÁVNIKOVÝ

#### s kompostom a pieskom

Špeciálny substrát so stabilnou štruktúrou na báze kvalitného drveného kôrového a zeleného kompostu a rašeliny. S prídavkom triedeného piesku pre vylepšenie drenážnych vlastností a zabraňovaniu hromadenia vlhkosti.



Kód	balenie	pal.
<b>2450</b>	45 l	42



### TRÁVNIKOVÝ

#### s kremičitým pieskom Premium

Ťažší typ vzdušného jemného substrátu s kremičitým pieskom, optimálne vyhnojovaný, s neutrálnym pH, vhodný na výsevy, rekonštrukcie trávnikov a ako podklad pre pokladanie kobercových trávnikov. Je tiež vhodný pre doplňovanie už vyrastených trávnikov, kde obmedzí plstnatie, tvorbu machov, zaisťujú dobrú drenáž a dodá trávníku živiny.



Kód	balenie	pal.
<b>2440</b>	40 l	42



### BALKÓNOVÉ KVETY S KOKOSOM

Špeciálna zmes upravených drvených kokosových vlákien a obalov kokosových orechov určená pre pestovanie a úpravu substrátov izbových a balkónových rastlín. Obzvlášť vhodný substrát pre rastliny, ktoré potrebujú vzdušný, ľahký a štruktúrny substrát. Tento substrát je zlisovaný do malej kocky, ktorá po namočení do vody zväčší svoj objem až na 7 litrov substrátu.



Kód	balenie	pal.
<b>920</b>	450 g	-



**SURFÍNIE**

Substrát pre kyslomilné balkónové rastliny, najmä pre previsnuté petúnie, surfínie, Million Bells, begónie, fuchsie, ktoré sú náročné na živiny, nižšie pH a vysoký obsah železa. Je vyrobený z kvalitnej kyslej vrchoviskovej rašeliny, kompostovanej kôry a prírodného humusu. Je výdatne obohatený živinami a stopovými prvkami, najmä železom v chelátovej forme. Spoločne s kyslou reakciou a dobrou zásobou živín zabraňuje tvorbe chlorózu.



Kód	balenie	pal.
<b>1020</b>	50 l	51



**PARADAJKY A ZELENINA**

Substrát pre paradajky a zeleninu sa používa na pestovanie paradajok, papriek, uhoriek, zeleniny a ostatných rastlín, vyžadujúcich strednú zásobu živín, pestovaných v pestovateľských nádobách a v záhonoch. Je tiež vhodný na vylepšenie pôdy v záhonoch pri výsadbe. Nie je vhodný pre výsev ani pre rastliny citlivé na obsah solí!



Kód	balenie	pal.
<b>1750</b>	50 l	51



**RODODENDRÓNY A AZALKY**

Špeciálny substrát určený na presádzanie a pestovanie rododendrónov, azaliiek, vresov, vresovcov, čučoriedok, brusníc a ďalších kyslomilných rastlín. Je tiež vhodný na úpravu príliš alkalického voľnej pôdy a alkalického pôdy v kvetináčoch. Substrát je vyrobený z kvalitnej kyslej vrchoviskovej rašeliny, kompostovanej kôry a prírodného humusu.



Kód	balenie	pal.
<b>1350</b>	50 l	51



**ČUČORIEDKY A BRUSNICE**

Substrát so stopovými prvkami a živinami, vhodnou kyslostou, optimálnou vododržnosťou a dostatkom vzduchu zabezpečuje zdravý vývoj koreňového systému a bohatú úrodu. Navyše obsahuje zeolit, ktorý má vynikajúce vlastnosti na výmenu iónov a zabraňuje vyplaveniu živín. Substrát je vhodný pre pestovanie čučoriedok a brusníc, ako aj ďalších kyslomilných rastlín, ktoré sú náročné na stabilne nižšie pH a na dostatok živín a vlahy.



Kód	balenie	pal.
<b>1050</b>	50 l	51



**ZÁHRADNÍCKY KOMPOST**

Substrát s vysokým obsahom fosforu, draslíka a vápnika. Je zvlášť vhodný na zlepšovanie pôd pred výsadbou škólkarského materiálu, pri sadovníckych realizáciách, pred založením trávnikov, záhonov, alebo ako prísada do substrátu, ktorá zadržiava vlhkosť a obsahuje veľké množstvo živín.



Kód	balenie	pal.
<b>4230</b>	40 l	42
<b>4220</b>	1 m <sup>3</sup>	1



### JAHODY

Substrát pre jahody sa používa na pestovanie jahôd a iného drobného ovocia v pestovateľských nádobách (kontajnery, kvetináče ...), v nadzemných aj v klasických záhonoch. Substrát vytvára priaznivé podmienky pre zdravý vývoj rastlín.



Kód	balenie	pal.
1756	50 l	51



### LEVANDULE A STREDOMORSKÉ RASTLINY

Substrát pre stredomorské rastliny a levandule sa používa na pestovanie stredomorských rastlín, levandule, stredomorských bylín a paliem. Substrát je vhodný na pestovanie v nádobách i vo voľnej pôde. Substrát vytvára priaznivé podmienky pre zdravý vývoj rastlín.



Kód	balenie	pal.
1752	20 l	132



### CITRUSY A SUBTROPICKÉ RASTLINY

Určený pre pestovanie citrusov, oleandrov, olivovníkov, paliem a všetkých ďalších stredomorských rastlín vysádzaných v záhonoch, v nádobách, alebo aj izbových rastlín letných vonku v kvetináčoch.



Kód	balenie	pal.
1754	20 l	132



### ORCHIDEJE

Špeciálny substrát na pestovanie a presádzanie orchideí. Substrát je vyrobený z kvalitnej pínovej kôry a hrubej bielej rašeliny. Táto hrubozrnná zmes zaručuje optimálne podmienky pre zdravý rast a bohaté kvitnutie orchideí.



Kód	balenie	pal.
550	5 l	270



### HORTENZIE

Profesionálny pestovateľský substrát určený na výsadbu a presádzanie všetkých druhov hortenzií. Je vyrobený zo zmesi kvalitnej rašeliny s upraveným pH, ktoré zaisťuje optimálnu štruktúru pre korene, vysokú absorpciu vody a dostatočné prevzdušnenie.

**NEW**



Kód	balenie	pal.
2425	50 l	51



**ORCHIDEJE**

Špeciálna zmes upravených drvených kokosových vlákien a obalov kokosových orechov, ktoré zaisťujú orchideám optimálny rast, kvitnutie a dostatok vzduchu v substráte. Tieto kokosové vlákna je možné ďalej miešať s rašelinou a píniovou kôrou podľa nárokov jednotlivých druhov orchideí. Tento substrát je zlisovaný do malej kocky, ktorá po namočení do vody zväčší svoj objem až na 4 litre substrátu.



Kód	balenie	pal.
<b>910</b>	350 g	-



**ZÁHRADNÍCKY**

Univerzálny substrát na pestovanie kvetín, zeleniny, drevín a na vylepšenie pôdy na záhonoch. Vyznačuje sa stabilnou štruktúrou s vynikajúcou zásobou vzduchu a sorpciou vody. Je obohatený základnými živinami a mikroprvkami pre správny rast a vývoj rastlín. Je vhodný na pestovanie rastlín v záhonoch, v nádobách a tiež na vylepšovanie pôdy pri výsadbách nielen na záhrade.



Kód	balenie	pal.
<b>2301</b>	20 l	132
<b>2351</b>	50 l	51
<b>2401</b>	75 l	39



**BYLINKY A KORENIE**

Špeciálny substrát s ideálnou štruktúrou pre pestovanie bylín a korenia v nádobách doma i vonku, ktorý je vhodný aj na ich výsev. Vyznačuje sa vynikajúcou vododržnosťou a vzdušnou kapacitou a vytvára tak priaznivé podmienky pre rast a zdravý vývoj rastlín. Použitie tohto špeciálneho substrátu je jedným z predpokladov pre radosť aj úžitok z vlastnej voňavej bylinkovej záhrady.



Kód	balenie	pal.
<b>1251</b>	20 l	132



**IZBOVÉ KVETY**

Substrát určený na pestovanie väčšiny izbových rastlín okrasných kvetom a listom. Vyznačuje sa dlhodobou stabilnou štruktúrou a vytvára priaznivé podmienky pre zdravý rast a vývoj izbových rastlín. Substrát neobsahuje fermentovanú kôru ani kompost, je optimálne vzdušný a vododržný. Eliminuje výskyt plesní a mušiek a prináša tak radosť z úspešného pestovania na dlhý čas.



Kód	balenie	pal.
<b>201</b>	10 l	238
<b>301</b>	20 l	132



**BALKÓNOVÉ KVETY**

Špeciálny substrát pre balkónové rastliny, najmä pre pelargónie, ktoré sú náročné na živiny. Je výdatne zásobený živinami a stopovými prvkami. Vyznačuje sa trvalo stabilnou štruktúrou, ktorá zaručuje optimálne prevzdušnenie a vododržnosť. Vďaka svojim vlastnostiam zabezpečuje vitalitu, veľký nárast, bohaté kvitnutie a vyfarbené kvety nielen muškátov, ale všetkých balkónových rastlín.



Kód	balenie	pal.
<b>701</b>	20 l	132
<b>801</b>	50 l	51
<b>901</b>	75 l	39



### SUBSTRÁT MYKOFLOR

Univerzálny s mykorhízou.

Najkvalitnejšia borkovaná biela rašelina 70%  
 Frézovaná biela rašelina 30%  
 Zeolit v 40 kg/m<sup>3</sup>  
 6 druhov symbiotických mykorhíznych húb  
 Start&Gro 14 - 16 - 18 so stopovými prvkami 1,5 kg/m<sup>3</sup>  
 Dolomitický vápenec s vysokým obsahom horčíka  
 pH 5,6 – 6,1  
 EC 1,2 - 1,4 mS/cm

Kód	balenie	pal.
<b>4192</b>	75 l	39



### BALKÓNOVÉ RASTLINY

Určený pre pestovanie všetkých balkónových rastlín okrasných kvetom aj listom, zvlášť všetkých druhov pelargónie. Je tiež ideálny pre všetky druhy záhonových letničiek.

Najkvalitnejšia borkovaná biela rašelina 70%  
 Frézovaná biela rašelina 30%  
 Zeolit v 40 kg/m<sup>3</sup>  
 PG mix 14 - 16 - 18 so stopovými prvkami 1,5 kg/m<sup>3</sup>  
 Dolomitický vápenec s vysokým obsahom horčíka  
 pH 5,6 - 6,1  
 EC 1,2 - 1,4 mS/cm

Kód	balenie	pal.
<b>4110</b>	75 l	39



### S HYDROGELOM

Určený pre pestovanie všetkých balkónových rastlín okrasných kvetom aj listom v nádobách, kde sa vďaka hydrogelu zníži frekvencia zálievok.

Najkvalitnejšia hrubá borkovaná biela rašelina 70%  
 Frézovaná biela rašelina 30%  
 Zeolit v 40 kg/m<sup>3</sup>  
 PG mix 14 - 16 - 18 so stopovými prvkami 1,5 kg/m<sup>3</sup>  
 Dolomitický vápenec s vysokým obsahom horčíka  
 pH 5,4 - 5,9  
 EC 1,2 - 1,4 mS/cm

Kód	balenie	pal.
<b>4115</b>	75 l	39



### RODODENDRÓNY, AZALKY A VRESY

Určený pre pestovanie a výsadbu rododendronov, azaliek a ďalších vresoviskových kyslomilných rastlín.

Najkvalitnejšia borkovaná biela rašelina 50%  
 Frézovaná biela rašelina 50%  
 Zeolit v 20 kg/m<sup>3</sup>  
 PG mix 14 - 16 - 18 so stopovými prvkami 1,2 kg/m<sup>3</sup>  
 Železo v chelátovej forme 40 g/m<sup>3</sup>  
 pH 4,0 - 4,6  
 EC 0,8-1,0 mS/cm

Kód	balenie	pal.
<b>4130</b>	75 l	39



### SUBSTRÁT VÝSEVNÝ

Určený pre výsev kvetín, zeleniny a okrasných drevín.

Najkvalitnejšia borkovaná biela rašelina 45%  
 Frézovaná biela rašelina 45%  
 Kremičitý piesok 10%  
 PG mix 14 - 16 - 18 so stopovými prvkami 0,6 kg/m<sup>3</sup>  
 Dolomitický vápenec s vysokým obsahom horčíka  
 pH 5,5 - 6,0  
 EC 0,6 - 0,8 mS/cm

Kód	balenie	pal.
<b>4210</b>	75 l	39

## PROFI substráty

### F02

Univerzálny substrát určený na vylepšenie štruktúry pôdy v záhonoch a pestovanie mnohých druhov kvetín, zeleniny, okrasných a ovocných drevín.

Frézovaná biela rašelina 90 %  
Čierna rašelina 10 %  
PG mix 14 - 16 - 18 so stopovými prvkami 1 kg/m<sup>3</sup>  
pH 5,6 - 6,3  
EC 1,2 - 1,4 mS/cm



**Florcom**  
PROFESSIONAL

Kód	balenie	pal.
<b>4420</b>	250 l	18
<b>4425</b>	5,8 m <sup>3</sup>	1

### F02Z

Univerzálny substrát určený na vylepšenie štruktúry pôdy v záhonoch a pestovanie mnohých druhov kvetín, zeleniny, okrasných a ovocných drevín.

Frézovaná biela rašelina 90 %  
Čierna rašelina 10 %  
PG mix 14 - 16 - 18 so stopovými prvkami 1 kg/m<sup>3</sup>  
pH 5,6 - 6,3  
EC 1,2 - 1,4 mS/cm  
Zeolit v 30 kg/m<sup>3</sup>



Kód	balenie	pal.
<b>4430</b>	250 l	18
<b>4435</b>	5,8 m <sup>3</sup>	1

### B02

Špeciálny substrát určený na pestovanie všetkých druhov črepníkových, balkónových kvetín a trvaliek.

Najkvalitnejšia borkovaná biela rašelina 60 %  
Frézovaná biela rašelina 30 %  
Čierna rašelina 10 %  
Start&Gro 14-16-18 so stopovými prvkami 1,5 kg/m<sup>3</sup>  
MICROMAX Premium 100 g/m<sup>3</sup>  
Dolomitický vápenec s vysokým obsahom horčíka  
Zvlhčovacie činidlo 100 ml/m<sup>3</sup>  
pH 5,6-6,2



Kód	balenie	pal.
<b>4455</b>	250 l	18
<b>4456</b>	5,8 m <sup>3</sup>	1

### B02Z

Špeciálny substrát určený na pestovanie všetkých druhov črepníkových, balkónových kvetín a trvaliek.

Najkvalitnejšia borkovaná biela rašelina 60 %  
Frézovaná biela rašelina 30 %  
Čierna rašelina 10 %  
Zeolit 40 kg/m<sup>3</sup>  
Start&Gro 14-16-18 so stopovými prvkami 1,5 kg/m<sup>3</sup>  
MICROMAX Premium 100 g/m<sup>3</sup>  
Dolomitický vápenec s vysokým obsahom horčíka  
Zvlhčovacie činidlo 100 ml/m<sup>3</sup>  
pH 5,6-6,2



Kód	balenie	pal.
<b>4465</b>	250 l	18
<b>4466</b>	5,8 m <sup>3</sup>	1

**SVB**

Substrát určený na výsev a množenie rastlín.

100 % borkovaná rašelina  
0,7 kg/m<sup>3</sup> PGmix  
pH 5,5 - 6,0



**Florcom**  
PROFESSIONAL

Kód	balenie	pal.
<b>4450</b>	250 l	18
<b>4451</b>	5,8 m <sup>3</sup>	1

**B12Z**

Špeciálny substrát určený na pestovanie všetkých druhov črepníkových, balkónových kvetín a trvaliek.

Najkvalitnejšia borkovaná biela rašelina 60 %  
Frézovaná biela rašelina 30 %  
Čierna rašelina 10 %  
Zeolit 40 kg/m<sup>3</sup>  
Start&Gro 14-16-18 so stopovými prvkami 1,5 kg/m<sup>3</sup>  
MICROMAX Premium 100 g/m<sup>3</sup>  
Dolomitický vápenec s vysokým obsahom horčíka  
Zvlhčovacie činidlo 100 ml/m<sup>3</sup>  
pH 5,6–6,2



Kód	balenie	pal.
<b>4470</b>	250 l	18
<b>4471</b>	5,8 m <sup>3</sup>	1

**SCH02**

Špeciálny substrát určený na pestovanie všetkých druhov črepníkových chryzantém.

Najkvalitnejšia borkovaná biela rašelina 60 %  
Frézovaná biela rašelina 30 %  
Čierna rašelina 10 %  
Zeolit v 40 kg/m<sup>3</sup>  
PG mix 14 - 16 - 18 so stopovými prvkami 1,5 kg/m<sup>3</sup>, LAV 1 kg/m<sup>3</sup>  
Dolomitický vápenec s vysokým obsahom horčíka  
pH 5,6 – 6,2  
EC 1,4 – 1,8 mS/cm



Kód	balenie	pal.
<b>4475</b>	250 l	18
<b>4476</b>	5,8 m <sup>3</sup>	1

**SCH03**

Špeciálny substrát určený na pestovanie všetkých druhov črepníkových chryzantém.

Najkvalitnejšia borkovaná biela rašelina 60 %  
Frézovaná biela rašelina 30 %  
Čierna rašelina 10 %  
Zeolit v 40 kg/m<sup>3</sup>  
PG mix 14 - 16 - 18 so stopovými prvkami 1,5 kg/m<sup>3</sup>, LAV 1 kg/m<sup>3</sup>  
Dolomitický vápenec s vysokým obsahom horčíka  
pH 5,6 – 6,2  
EC 1,4 – 1,8 mS/cm



Kód	balenie	pal.
<b>4478</b>	250 l	18
<b>4479</b>	5,8 m <sup>3</sup>	1

## PROFI substráty

### SBS-SK

Špeciálny substrát určený pre pestovanie previslých petúnií a všetky kyslomilné rastliny.

Najkvalitnejšia borkovaná biela rašelina 60 %  
Frézovaná biela rašelina 40 %  
Zeolit v 40 kg/m<sup>3</sup>  
PG mix 14 - 16 - 18 so stopovými prvkami 1,5 kg/m<sup>3</sup>  
Dolomitický vápenec s vysokým obsahom horčíka  
Železo v chelátovej forme 40 g/m<sup>3</sup>  
pH 4,5 – 4,9 | EC 1,4 -1,6 mS/cm



Kód	balenie	pal.
<b>4485</b>	250 l	18
<b>4486</b>	5,8 m <sup>3</sup>	1

### B12Z KOKOS

Profesionálny substrát s kokosom pre pestovanie citlivých rastlín.

Najkvalitnejšia borkovaná biela rašelina 60 %  
Frézovaná biela rašelina 40 %  
Kokosové vlákno 10 %  
Zeolit v 30 kg/m<sup>3</sup>  
Start&Gro 14 - 16 - 18 so stopovými prvkami 1 kg/m<sup>3</sup>  
Dolomitický vápenec s vysokým obsahom horčíka  
pH 5,8 – 6,2 | EC 1,2 – 1,4 mS/cm



Kód	balenie	pal.
<b>4495</b>	250 l	18
<b>4496</b>	5,8 m <sup>3</sup>	1

### B13Z KOKOS

Profesionálny substrát s kokosom pre pestovanie citlivých rastlín.

Najkvalitnejšia borkovaná biela rašelina 60 %  
Frézovaná biela rašelina 40 %  
Kokosové vlákno 10 %  
Zeolit v 30 kg/m<sup>3</sup>  
Start&Gro 14 - 1 - 18 so stopovými prvkami 1 kg/m<sup>3</sup>  
Dolomitický vápenec s vysokým obsahom horčíka  
pH 5,8 – 6,2 | EC 1,2 – 1,4 mS/cm



Kód	balenie	pal.
<b>4500</b>	250 l	18
<b>4501</b>	5,8 m <sup>3</sup>	1

### B12I

Profesionálny substrát s ílom pre pestovanie širokého sortimentu črepníkových a kontajnerovaných okrasných rastlín.

Najkvalitnejšia borkovaná biela rašelina 60 %  
Frézovaná biela rašelina 25 %  
Drevné vlákno 15 %  
Íl 40 kg/m<sup>3</sup>  
Multi mix 14-16-18 1,5 kg/m<sup>3</sup>  
pH 5,5 – 6,5 | EC 1,0 – 1,8 mS/cm



Kód	balenie	pal.
<b>44701</b>	250 l	15
<b>44712</b>	4,5 m <sup>3</sup>	1

## KLASMANN substráty

### KTS 1 - Fine (jemný)



Kód	balenie	m. j.	pal.
<b>48120</b>	210 l	ks	20

frakcia: 0 - 5 mm, výsev

### KTS 2 - Fine (jemný)



Kód	balenie	m. j.	pal.
<b>48270</b>	210 l	ks	20

frakcia: 0 - 5 mm, priesady

**KLASMANN DEILMANN**  
*we make it grow*

**KTS 2 - Standard**



Kód	balenie	m. j.	pal.
<b>48220</b>	210 l	ks	20

frakcia: 0 - 25 mm

**KTS 3 - Standard + íl**



**KLASMANN** **DEILMANN**  
*we make it grow*

Kód	balenie	m. j.	pal.
<b>48320</b>	210 l	ks	20

frakcia: 0 - 25 mm

**Rašelina frézovaná**

**NEW**



**Kyslá pH 3,5 - 4,5**

Kód	balenie	m. j.	pal.
<b>7951</b>	250 l	ks	15
<b>7952</b> <b>NEW</b>	150 l	ks	21

frakcia: 6 - 20 mm

**NEW**



**Neutrálna pH 5,5 - 6,5**

Kód	balenie	m. j.	pal.
<b>7961</b>	250 l	ks	15
<b>7962</b> <b>NEW</b>	150 l	ks	21

frakcia: 6 - 20 mm

**Substrát univerzálny**

**NEW**



**Neutrálny pH 5,5 - 6,5**

Kód	balenie	m. j.	pal.
<b>4510</b>	150 l	ks	21

frakcia: 6 - 20 mm, NPK 1,7 kg/m<sup>3</sup>

**Pindstrup Plus Orange**

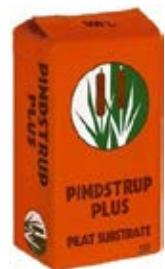

Kód	balenie	m. j.	pal.
<b>2800</b>	300 l	ks	-

frakcia: 0 - 10 mm

**Keramzit, Piesok**

**Keramzit - LIAPOR 8 - 16 mm** neupravený



Kód	balenie	m. j.	pal.
<b>60</b>	50 l	ks	36

**Keramzit - LIAFLOR 8 - 16 mm** upravený lesklý



Kód	balenie	m. j.	pal.
<b>65</b>	50 l	ks	36
<b>6510</b>	10 l	ks	66

**Pemza 7 - 14 mm**

**NEW**



Kód	frakcia	balenie	m. j.	pal.
<b>8054</b>	7-14 mm	BB 2 m <sup>3</sup>	-	-
<b>8056</b>	7-14 mm	50 l	ks	36
<b>80561</b>	3-7 mm	50 l	ks	36
<b>80540</b>	3-7 mm	BB 2 m <sup>3</sup>	-	-

**Piesok do pieskoviska 0 - 2 mm**



Kód	balenie	m. j.	pal.
<b>94014</b>	25 kg	ks	40

**LEN NA OBJEDNÁVKU**

## Vegetačné strechy

### Intenzívny substrát



Kód	balenie	m. j.	pal.
<b>2470</b>	1,7 m <sup>3</sup>	ks	1

Drvený liapor (Liadrain), tehlová drvina, rašelina, kompost, Start&Gro 14-16-18 so stopovými prvkami, pH 6,5 - 7,5; EC max. 0,8 mS/cm - hodnoty pH a EC vo vodnom výluhu 1:25

### Extenzívny substrát

**Florcom**



Kód	balenie	m. j.	pal.
<b>2480</b>	1,7 m <sup>3</sup>	ks	1

Drvený liapor (Liadrain), pórovité kamenivo, čistá tehlová drvina, bezburinný kompost, triedená borkovaná rašelina, Start&Gro 14 - 16 - 18 so stopovými prvkami, pH (CaCL2) 6,0 - 8,5; EC max. 0,65 mS/cm

### Minerálny - mobilná zeleň



Kód	balenie	m. j.	pal.
<b>2462</b>	45 L	ks	45

50% drvený liapor, 50% borkovaná rašelina, frakcia 7 - 20 mm +100 kg zeolitu/m<sup>3</sup> štartovacie hnojivo 1,5 kg/m<sup>3</sup>, pH 5,8 - 6,0

### Substrát strešný extenzívny



Kód	balenie	m. j.	pal.
<b>2460</b>	45 L	ks	39

Drvený liapor, tehlová drť, škvára, rašelina, PG mix 14 - 16 - 18 + stopové prvky pH 6,2 - 6,8

### Spojka k okrajovému profilu



Kód	m. j.
<b>999117</b>	ks

130/120 x 80 mm

Kód	m. j.
<b>9991171</b>	ks

130/90 x 60 mm

### Okrajový profil



Kód	m. j.
<b>999116</b>	ks

2000/120 x 80 mm

Kód	m. j.
<b>9991161</b>	ks

2000/90 x 60 mm

### Rohový profil



Kód	m. j.
<b>999120</b>	ks

500 + 500/120 x 80 mm

Kód	m. j.
<b>9991201</b>	ks

500 + 500/90 x 60 mm

### Kontrolná šachta



Kód	m. j.
<b>999122</b>	ks

šachta na plochu s výškou 100 mm

### Drenážna akumulčná rohož

2,102 x 0,98 m



Kód	balenie	m. j.	pal.
<b>999103</b>	2,06 m <sup>2</sup>	ks	218

450 m<sup>2</sup> = 218 ks/pal, výška štupla 4,0 cm, 21,26 l/m<sup>2</sup>

### Drenážna akumulčná rohož

1,91 x 0,96 m



Kód	balenie	m. j.	pal.
<b>999101</b>	1,838 m <sup>2</sup>	ks	299

555 m<sup>2</sup> = 302 ks/pal, výška štupla 2,5 cm, 10 l/m<sup>2</sup>

**Retenčno-vegetačná doska AQUADESK**



Kód	m. j.	pal.
<b>9991030</b>	ks	200

1200 x 600 x 20 mm

Je vyrobená z termicky spojených recyklovaných polyesterových vlákien. Oproti klasickému strešnému substrátu vyniká, okrem iného, hlavne nižšou váhou.



**Viacdruhový rozchodníkový koberec**



Kód	m. j.
<b>5501</b>	ks

850 x 2400 mm

Je vhodný na extenzívne zelené strechy, zložený z odolných druhov ako Sedum lydium, Sedum album, Sedum acre, Sedum sexangulare...

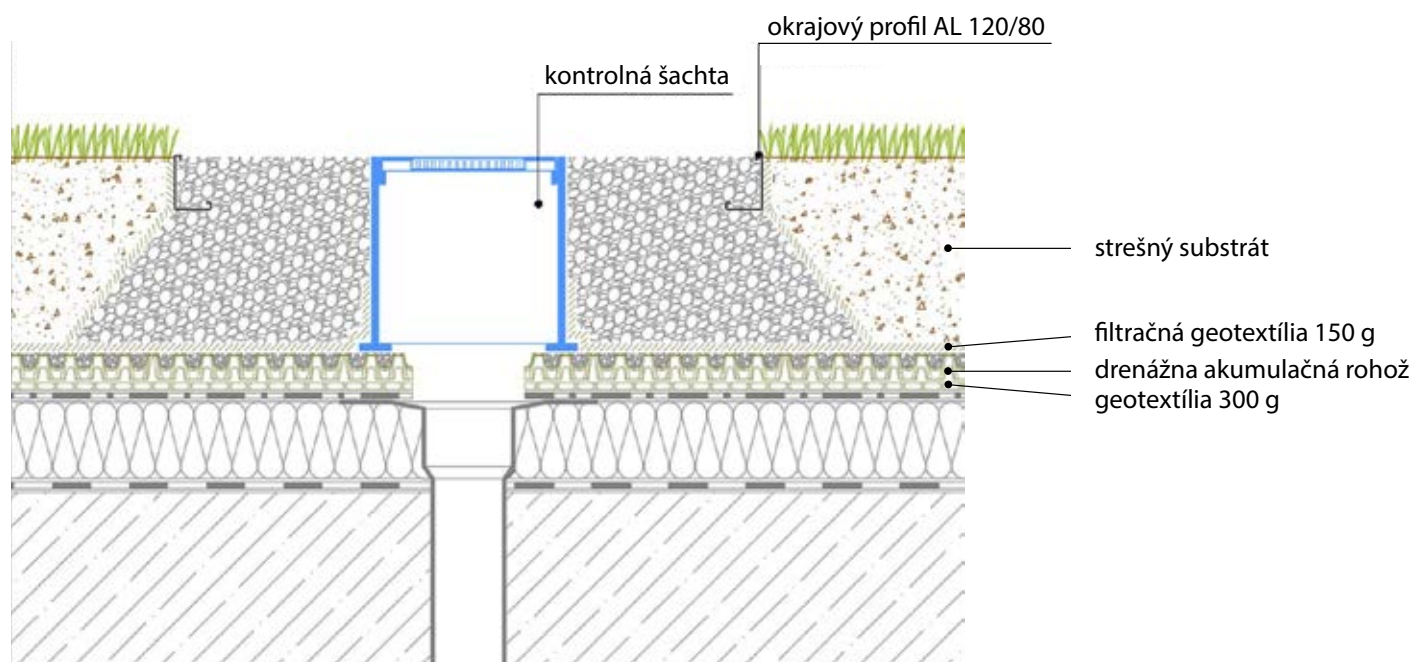

## Vertikálne systémy



## Vegetačná stena

### Modul

(priemer 90 mm)



Kód	farba	m. j.
<b>999202</b>	šedá	ks

1m<sup>2</sup> - 40 modulov

### Modul

(priemer 140 mm)



Kód	farba	m. j.
<b>999201</b>	čierna	ks
<b>999200</b>	šedá	ks

1m<sup>2</sup> - 18 modulov

### Membránové čerpadlo

12V - 5,5 l/min - 5,5 bar



Kód	m. j.
<b>999300</b>	ks

### Tlaková nádoba

0,75 l



Kód	m. j.
<b>999310</b>	ks

Zapojenie závlahy

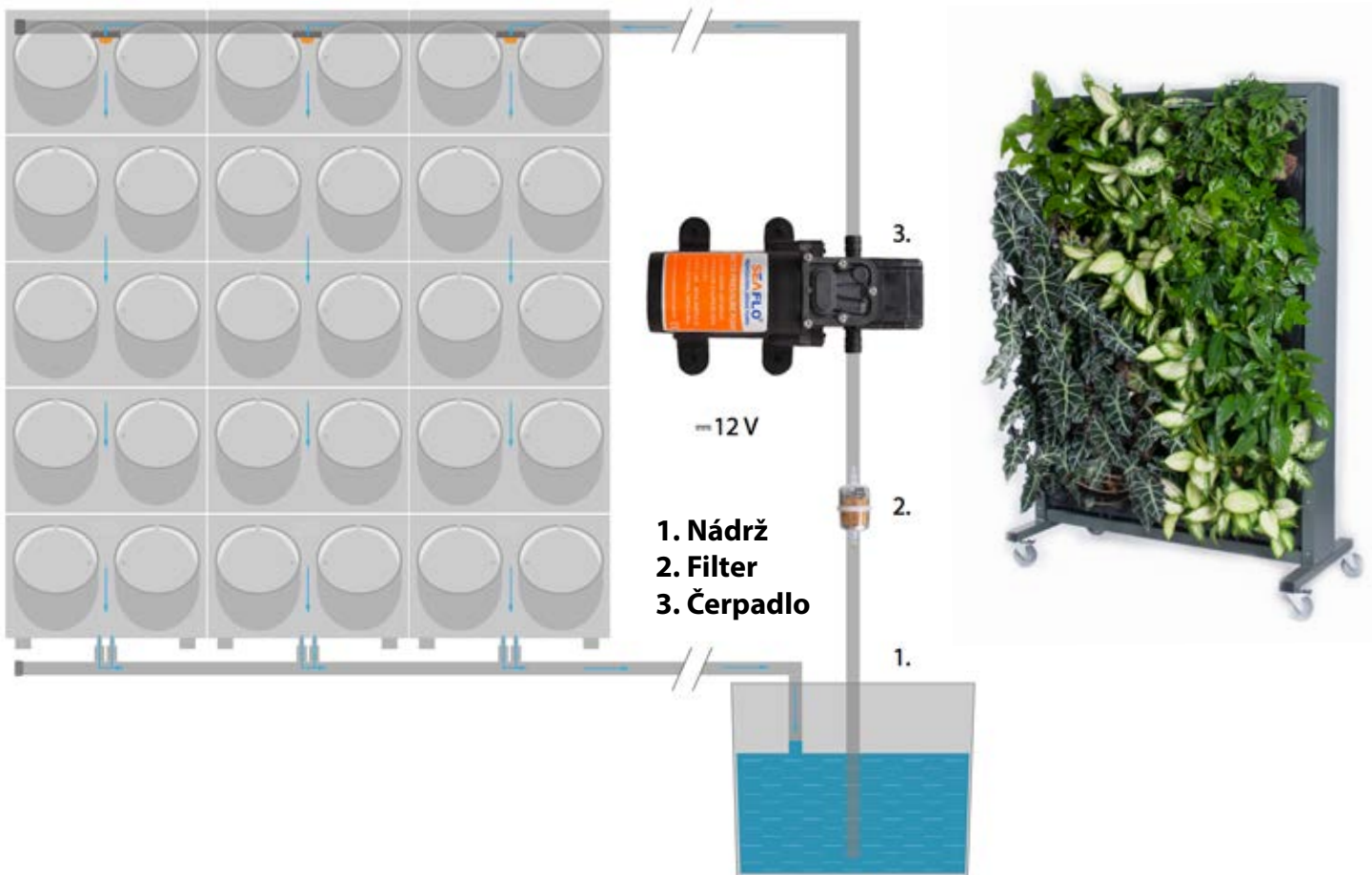

Rozmery modulu

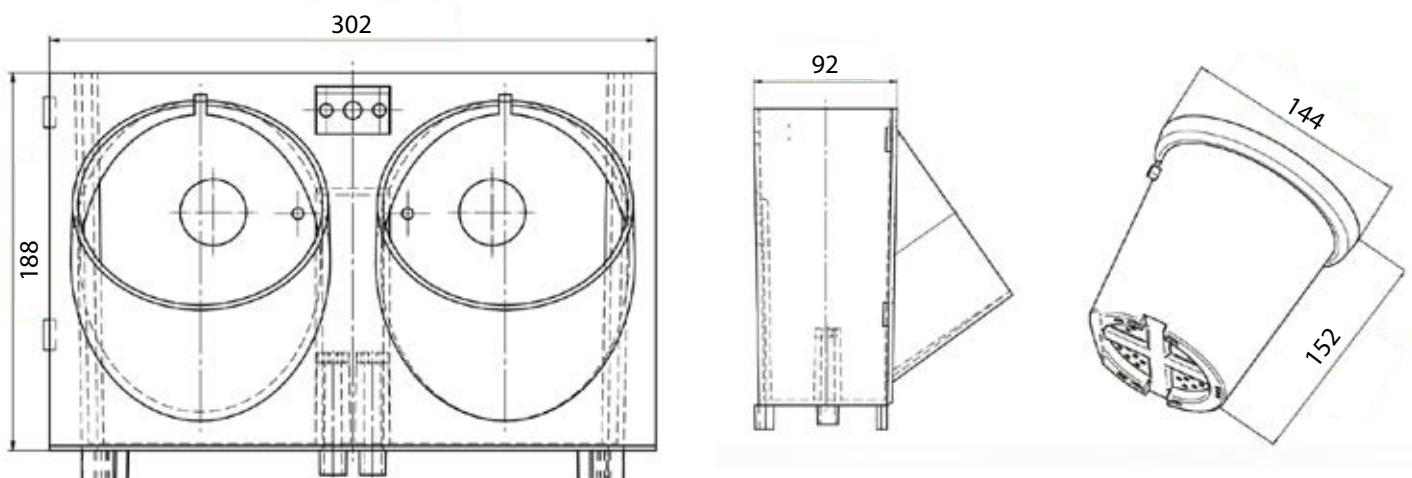

materiál	množstvo	hmotnosť	objem vody
PP PE	18/m <sup>2</sup>	0,7 kg	0,7 l

## Mulčovacia kôra

### Borovicová na trvalky



Kód	frakcia	balenie	m. j.	pal.
<b>53752</b>	0 - 10 mm	70 l	ks	42

### Borovicová triedená



Kód	frakcia	balenie	m. j.	pal.
<b>5370</b>	0 - 40 mm	70 l	ks	42
<b>5375</b>	0 - 60 mm	70 l	ks	42

### Borovicová PREMIUM



Kód	frakcia	balenie	m. j.	pal.
<b>53751</b>	20 - 80 mm	70 l	ks	45

### Smreková



Kód	balenie	m. j.	pal.
<b>5300</b>	70 l	ks	39

**Florcom**

## Štiepky



Kód	farba	balenie	m. j.	pal.
<b>53141</b>	oranžová	50 l	ks	42



Kód	farba	balenie	m. j.	pal.
<b>53131</b>	červená	50 l	ks	42



Kód	farba	balenie	m. j.	pal.
<b>53121</b>	hnedá	50 l	ks	42



Kód	farba	balenie	m. j.	pal.
<b>53111</b>	žltá	50 l	ks	42

## Píniová kôra Premium Quality



Kód	frakcia	balenie	m. j.	pal.
<b>4015</b>	8 - 15 mm	70 l	ks	42



Kód	frakcia	balenie	m. j.	pal.
<b>41525</b>	15 - 25 mm	70 l	ks	39



Kód	frakcia	balenie	m. j.	pal.
<b>42540</b>	25 - 40 mm	70 l	ks	39



Kód	frakcia	balenie	m. j.	pal.
<b>44060</b>	40 - 60 mm	70 l	ks	39



Kód	frakcia	balenie	m. j.	pal.
<b>460100</b>	60 - 100 mm	70 l	ks	39



Píniová kôra prémiovej kvality. Možno ju použiť vo všetkých typoch záhrad.



**Full Season**



Kód	balenie	m. j.	pal.
<b>70514</b>	15 kg	ks	66

27+05+05+2MgO/8-9M

**Shade Special**



Kód	balenie	m. j.	pal.
<b>70522</b>	15 kg	ks	66

11+05+05+8Fe

**Maintenance**



Kód	balenie	m. j.	pal.
<b>70504</b>	15 kg	ks	66

25+05+12/2-3M

**All Round**



Kód	balenie	m. j.	pal.
<b>70502</b>	15 kg	ks	66

24+05+08+2MgO/4-5M

**Spring & Summer**



Kód	balenie	m. j.	pal.
<b>70496</b>	15 kg	ks	66

20+00+07+6CaO+3MgO/2-3M

**New Grass**



Kód	balenie	m. j.	pal.
<b>70500</b>	15 kg	ks	66

20+20+08/3M

**Stress Control**



Kód	balenie	m. j.	pal.
<b>70510</b>	15 kg	ks	66

16+05+22/2-3M

**Autumn & Winter**



Kód	balenie	m. j.	pal.
<b>70498</b>	15 kg	ks	66

12+05+20+5CaO+2MgO/2-3M

**Pre Winter**



Kód	balenie	m. j.	pal.
<b>70506</b>	15 kg	ks	66

14+05+21+2MgO/4-5M

**Flora**



Kód	balenie	m. j.	pal.
<b>70512</b>	15 kg	ks	66

15+09+11+3MgO/5-6M

## LSP Spring &amp; Summer



Kód	balenie	m. j.	pal.
<b>41330105</b>	5 kg	ks	120

20-0-7+6CaO+3MgO/2-3M

## LSP New Grass



Kód	balenie	m. j.	pal.
<b>41930105</b>	5 kg	ks	120

20-20-8/3M



## LSP All Round



Kód	balenie	m. j.	pal.
<b>41980105</b>	5 kg	ks	120

24-5-8+2MgO/4-5M

## LSP Pre-Winter



Kód	balenie	m. j.	pal.
<b>42420105</b>	5 kg	ks	120

14-5-21+2MgO/4-5M

## Sportmaster CRF Mini

## Active



Kód	balenie	m. j.	pal.
<b>70751</b>	25 kg	ks	50

15-5-15+4CaO+2MgO

## Start



Kód	balenie	m. j.	pal.
<b>70759</b>	25 kg	ks	50

19-19-5+2MgO+TE

## Stress Control



Kód	balenie	m. j.	pal.
<b>70755</b>	25 kg	ks	50

10-5-21+4CaO+2MgO

## High N



Kód	balenie	m. j.	pal.
<b>70757</b>	25 kg	ks	50

24-5-11+3CaO

## HNOJIVÁ

### ProTurf, Compo

#### ProTurf



Kód	balenie	m. j.	pal.
<b>70557</b>	25 kg	ks	50

12+05+20+2CaO+2MgO/2M

#### ProTurf



Kód	balenie	m. j.	pal.
<b>70556</b>	25 kg	ks	50

15+05+15+2CaO+2MgO/2M

#### ProTurf



Kód	balenie	m. j.	pal.
<b>70555</b>	25 kg	ks	50

21+05+06+2,5CaO+2,5MgO/2M

#### NovaTec Classic



Kód	balenie	m. j.	pal.
<b>76020</b>	25 kg	ks	42

12-8-16+3MgO+TE/1,5M

#### NovaTec N-Max



Kód	balenie	m. j.	pal.
<b>76010</b>	25 kg	ks	42

24-5-5+2MgO+TE/1,5M

#### NovaTec Premium



Kód	balenie	m. j.	pal.
<b>76025</b>	25 kg	ks	42

15-3-20+3MgO+TE

### Trávníkové hnojivá



Kód	balenie	zloženie	m. j.	pal.
<b>69882</b>	25 kg	20-7-10+TE	ks	48
<b>73200</b>	25 kg	12-11-18+TE	ks	48



Kód	balenie	výdatnosť	m. j.	pal.
<b>70113</b>	5 kg	200 m <sup>2</sup>	ks	200
<b>70112</b>	10 kg vedro	400 m <sup>2</sup>	ks	52
<b>70111</b>	25 kg	1000 m <sup>2</sup>	ks	40

10-0-25 + 0,5MgO+13S



Kód	balenie	výdatnosť	m. j.	zloženie
<b>70101</b>	25 kg	1000 m <sup>2</sup>	ks	15-3-8+3MgO+0,8Fe
<b>701010</b>	10 kg	400 m <sup>2</sup>	ks	15-3-8+3MgO+0,8Fe
<b>70103</b>	5 kg	200 m <sup>2</sup>	ks	15-3-8+3MgO+0,8Fe

### Spring & Start / Jar



Kód	balenie	m. j.	pal.
7660	5 kg	ks	90

25-6-10 + TE

#### Výhody

- Odolnejšie voči burine.
- Vysoký obsah dusíka.
- Rýchly štart.
- Odolnejšie voči machu.
- Dlhodobé pôsobenie.

### All Season / Leto



Kód	balenie	m. j.	pal.
7661	5 kg	ks	90

19-5-20 + TE

#### Výhody

- Odolnejšie voči stresu.
- Vysoký obsah živín.
- Univerzálne použitie.
- Odolnejšie voči machu.
- Dlhodobé pôsobenie.

### Winter Ready / Jeseň



Kód	balenie	m. j.	pal.
7662	5 kg	ks	90

11-8-27 + TE

#### Výhody

- Odolnejšie voči mrazu.
- Vysoký obsah draslíka.
- Rýchla regenerácia.
- Odolnejšie voči machu.
- Dlhodobé pôsobenie.

### Záhradné hnojivo



Kód	balenie	m. j.	pal.
7665	3 kg	ks	90

16-3-6 + TE

#### Výhody

- Vysoký obsah dusíka.
- Univerzálne použitie.
- Vysoký podiel organickej zložky.
- Dlhodobé pôsobenie.

Názov produktu	Doba pôsobenia	Obsah živín							Odporúčaný čas aplikácie													
		Celk. N (% obal.)	P <sub>2</sub> O <sub>5</sub>	K <sub>2</sub> O	MgO	SO <sub>3</sub>	CaO	Balenie (kg)	Dávka (g/m <sup>2</sup> )	Január	Február	Marec	Apríl	Máj	Jún	Júl	August	September	Október	November	December	
Spring & Start 25-6-10+22SO <sub>3</sub>	2-3 mesiace	25	6	10	-	22	-	5	min 20													
All season 19-5-20+4MgO+19,5SO <sub>3</sub>	2-3 mesiace	19	5	20	4	19,5	-	5	min 20													
Winter ready 11-8-27+3CaO+12,5SO <sub>3</sub>	2-3 mesiace	11	8	27	-	12,5	3	5	min 20													

Intenzívny trávnik      Extenzívny trávnik

## HNOJIVÁ

### Organické a organominerálne hnojivá

#### Gronamic Sport High N / Jar



Kód	balenie	m. j.	pal.
<b>70590</b>	25 kg	ks	40

16-3-6 +2MgO+0,5Fe

#### Gronamic Allround / Leto



Kód	balenie	m. j.	pal.
<b>70592</b>	25 kg	ks	40

10-4-5 +2MgO+0,5Fe



#### Gronamic Sport High K / Jeseň



Kód	balenie	m. j.	pal.
<b>70591</b>	25 kg	ks	40

7-0-20 +2MgO+0,5Fe

#### Kravský hnoj Marha-Jó



Kód	balenie	m. j.	pal.
<b>118</b>	4 kg	ks	138
<b>115</b>	25 kg	ks	60

### Pôdny kondicionér

#### Agrosil LR



Kód	balenie	m. j.	pal.
<b>76750</b>	25 kg	ks	50

1-10-0+45Silikáty (SiO<sub>2</sub>)

### Nova Range

#### Nova Pekacid



Kód	balenie	m. j.	pal.
<b>28560325</b>	25 kg	ks	48

0-60-20



### Hnojivá BOPON

#### Trávník



NEW

Kód	balenie	m. j.	bal.
<b>B1046</b>	1 kg	ks	12
<b>B1047</b>	3 kg	ks	3

#### Trávník proti machu



NEW

Kód	balenie	m. j.	bal.
<b>B1049</b>	1 kg	ks	12
<b>B1050</b>	3 kg	ks	1



#### Trávník proti burine



NEW

Kód	balenie	m. j.	bal.
<b>B1131</b>	1 kg	ks	12
<b>B1132</b>	3 kg	ks	3



## Rotačné

## Handy Pro ručný



Kód	objem	m. j.
<b>70560</b>	2 l	ks

## Easy Green



Kód	objem	rozptyl	m. j.
<b>70562</b>	12 l	1,2 - 3,4 m	ks

## Accu Pro One



Kód	objem	m. j.
<b>692199</b>	20 kg	ks

## ShakerPro



Kód	objem	m. j.
<b>705601</b>	1,5 kg	ks

## Accu Pro 360ST



Kód	objem	m. j.
<b>705671</b>	30 kg	ks



## Štrbinové

## Classic Drop Spreader



Kód	objem	rozptyl	m. j.
<b>70566</b>	30 l	0,55 m	ks

## Accu Pro Drop



Kód	m. j.
<b>705711</b>	ks



## HNOJIVÁ

### Listové hnojivá

#### Agroleaf Power High P



Kód	balenie	m. j.	pal.
<b>20940312</b>	2 kg	ks	72

12-52-5+TE

#### Agroleaf Power Total



Kód	balenie	m. j.	pal.
<b>20960312</b>	2 kg	ks	72

20-20-20+TE

#### Agroleaf High N



Kód	balenie	m. j.	pal.
<b>20950312</b>	2 kg	ks	72

31-11-11+TE

#### Agroleaf Power High K



Kód	balenie	m. j.	pal.
<b>20970312</b>	2 kg	ks	72

15-10-31+TE

### Osmocote - granulované s riadeným uvoľňovaním - 2. generácia

#### PRO 12-14M



Kód	balenie	m. j.	pal.
<b>706468</b>	25 kg	ks	50

18+09+10+2MgO+TE

#### PRO 8-9M



Kód	balenie	m. j.	pal.
<b>706467</b>	25 kg	ks	50

18+9+10+2MgO+TE

#### PRO 5-6M



Kód	balenie	m. j.	pal.
<b>706466</b>	25 kg	ks	50

19+9+10+2MgO+TE

#### PRO 3-4M



Kód	balenie	m. j.	pal.
<b>706465</b>	25 kg	ks	50

19+9+10+2MgO+TE

### Osmocote Špeciál

#### OSMOCOTE Bloom



Kód	balenie	m. j.	pal.
<b>70652</b>	25 kg	ks	50

12+07+18+TE/2-3M

#### OSMOCOTE Topdress



Kód	balenie	m. j.	pal.
<b>70656</b>	25 kg	ks	50

22+05+06+2MgO+TE/4-5M

## Osmocote - granulované s riadeným uvoľňovaním - 3. generácia

## OSMOCOTE Start



Kód	balenie	m. j.	pal.
<b>70654</b>	25 kg	ks	50

11-11-17+2MgO+TE/6W

## OsmoTop



Kód	balenie	m. j.	pal.
<b>70780</b>	25 kg	ks	40

22+05+10+2MgO+TE/2-3M



## OSMOCOTE Exact High K



Kód	balenie	m. j.	pal.
<b>706080</b>	25 kg	ks	50

12-07-19+TE/3-4M

## OSMOCOTE Exact High K



Kód	balenie	m. j.	pal.
<b>70612</b>	25 kg	ks	50

11-11-18+TE/5-6M

## OSMOCOTE Exact High K



Kód	balenie	m. j.	pal.
<b>70614</b>	25 kg	ks	50

11-11-18+TE/8-9M

## OSMOCOTE Exact Standard



Kód	balenie	m. j.	pal.
<b>70620</b>	25 kg	ks	50

16-09-12+2MgO+TE/3-4M

## OSMOCOTE Exact Standard



Kód	balenie	m. j.	pal.
<b>70622</b>	25 kg	ks	50

15-09-12+2MgO+TE/5-6M

## OSMOCOTE Exact Standard



Kód	balenie	m. j.	pal.
<b>70624</b>	25 kg	ks	50

15-09-11+2MgO+TE/8-9M

## Dávkovače hnojiva



Kód	popis
<b>583503</b>	DOSATRON - do 3 m <sup>3</sup> /hod
<b>5835081</b>	DOSATRON - do 9 m <sup>3</sup> /hod



Kód	popis
<b>583501</b>	MIXTRON - do 3 m <sup>3</sup> /hod

LEN NA  
OBJEDNÁVKU

Kód	popis
<b>583500</b>	Mix Rite - do 25 m <sup>3</sup> /hod

**Exact DCT Protect**



Kód	balenie	m. j.	pal.
<b>70606</b>	25 kg	ks	50

14+08+11+2MgO+TE/8-9M

**Exact DCT Protect**



Kód	balenie	m. j.	pal.
<b>70604</b>	25 kg	ks	50

14+08+11+2MgO+TE/5-6M

**Exact DCT Protect**



Kód	balenie	m. j.	pal.
<b>70608</b>	25 kg	ks	50

14+08+11+2MgO+TE/12-14M

**Exact DCT Hi End**



Kód	balenie	m. j.	pal.
<b>70602</b>	25 kg	ks	50

15+09+11+2MgO+TE/8-9M

**Exact DCT Hi End**



Kód	balenie	m. j.	pal.
<b>70600</b>	25 kg	ks	50

15+09+12+2MgO+TE/5-6M

**Exact DCT Hi End**



Kód	balenie	m. j.	pal.
<b>70603</b>	25 kg	ks	50

15+08+11+2MgO+TE/12-14M

**Exact DCT High K**



Kód	balenie	m. j.	pal.
<b>706081</b>	25 kg	ks	50

12+07+19+TE/5-6M

**Exact DCT High K**



Kód	balenie	m. j.	pal.
<b>706082</b>	25 kg	ks	50

12+07+19+TE/8-9M

**Exact DCT High K**



Kód	balenie	m. j.	pal.
<b>706083</b>	25 kg	ks	50

12+07+19+TE/12-14M



## Osmocote - granulované s riadeným uvoľňovaním - 5. generácia

## OSMOCOTE 5 S-Curved



Kód	balenie	m. j.	pal.
<b>88760225</b>	25 kg	ks	50
16-08-12+2,2MgO+TE/5-6M			

## OSMOCOTE 5 S-Curved



Kód	balenie	m. j.	pal.
<b>88770225</b>	25 kg	ks	50
16-08-12+2,2MgO+TE/8-9M			

## Universol - kryštalické - vodorozpustné

## Violet



Kód	balenie	m. j.	pal.
<b>70754</b>	25 kg	ks	48
10+10+30+3,3MgO+TE			

## Yellow



Kód	balenie	m. j.	pal.
<b>70752</b>	25 kg	ks	48
12+30+12+2,2MgO+TE			

## Blue



Kód	balenie	m. j.	pal.
<b>70756</b>	25 kg	ks	48
18+11+18+2,5MgO+TE			

## Green



Kód	balenie	m. j.	pal.
<b>70750</b>	25 kg	ks	48
23+06+10+2,7MgO+TE			

## Orange



Kód	balenie	m. j.	pal.
<b>70758</b>	25 kg	ks	48
16+05+25+3,4MgO+TE			

## Basis



Kód	balenie	m. j.	pal.
<b>70760</b>	25 kg	ks	48
04+19+35+4,1MgO+TE			

## Hard Water 225



Kód	balenie	m. j.	pal.
<b>70766</b>	25 kg	ks	48
11+10+28+2MgO+TE			

## Hard Water 211



Kód	balenie	m. j.	pal.
<b>70764</b>	25 kg	ks	48
23-10-10+2MgO+TE			

## HNOJIVÁ

### Terrasan

#### Na orchideje



Kód	balenie	m. j.	pal.
<b>76491</b>	500 ml	ks	900

4+4+7 12ks/kartón

#### Na muškáty



Kód	balenie	m. j.	pal.
<b>76410</b>	1 l	ks	576

8+3+5 12ks/kartón



#### Horká soľ



Kód	balenie	m. j.	pal.
<b>84748</b>	1 l	ks	-
<b>84742</b>	1 kg	ks	-
<b>84744</b>	3 kg	ks	-
<b>76590</b>	2,5 kg	ks	320
<b>73180</b>	25 kg	ks	-

(MgSO<sub>4</sub>) 16+13% 8ks/kartón

## Hnojivo kryštálické Florfit Premium

#### Izbové rastliny



Kód	balenie	m. j.	kart.
<b>76680</b>	500 g	ks	5 ks

#### Balkónové rastliny



Kód	balenie	m. j.	kart.
<b>76682</b>	500 g	ks	5 ks

#### Plod a kvet



Kód	balenie	m. j.	kart.
<b>76686</b>	500 g	ks	5 ks

#### Zelenina



Kód	balenie	m. j.	kart.
<b>76684</b>	500 g	ks	5 ks

## Na okrasné rastliny univerzálne



Kód	balenie	m. j.
<b>B1042</b>	1 kg	ks

NPK 10:5:10  
Mg 5% S27% + Micro

## Hnojivo na čučoriedky



Kód	balenie	m. j.
<b>B1130</b>	1 kg	ks

NPK 5-5-14  
Ca 2% Mg 5% S27%

## Hnojivo na hortenzie



Kód	balenie	m. j.
<b>B1127</b>	1 kg	ks

## Hnojivo na ihličnany



Kód	balenie	m. j.
<b>B1052</b>	1 kg	ks

## Komposter - urýchľovač kompostu



Kód	balenie	m. j.	kart.
<b>B1126</b>	1 kg	ks	12

## Antimuscus proti machu



Kód	balenie	m. j.
<b>80324</b>	5 kg	ks
<b>80325</b>	1 kg	ks

### Hnojivo na paradajky, korenie, plod. zeleninu



Kód	balenie	m. j.
<b>B1174</b>	1 kg	ks

### Jesenné hnojivo univerzálne



Kód	balenie	m. j.
<b>B1076</b>	1 kg	ks

N 3,5% P 10% K 20%  
Ca 8% S 4,8%

### Jesenné hnojivo na ihličnany



Kód	balenie	m. j.
<b>B1078</b>	1 kg	ks

P 10% K 20%  
Mg 4,5% S 10%

### Záhradnícke vápno



Kód	balenie	m. j.
<b>B1164</b>	1 kg	ks

### Hnojivo na Juky, Draceny, Palmy



Kód	balenie	m. j.
<b>B1037</b>	500 ml	ks

### Na rododendróny a azalky 0,5l



Kód	balenie	m. j.
<b>B1165</b>	500 ml	ks

### Hnojivo na previslé surfinie a petúnie



Kód	balenie	m. j.
<b>B1017</b>	500 ml	ks

### Hnojivo na muškáty, pelargónie



Kód	balenie	m. j.
<b>B1015</b>	1 l	ks

### Hnojivo na ihličnany



Kód	balenie	m. j.
<b>B1024</b>	1 l	ks

### Hnojivo na kvitnúce rastliny



Kód	balenie	m. j.
<b>B1009</b>	1 l	ks

### Na hortenzie - GÉL



Kód	balenie	m. j.
<b>B1268</b>	500 ml	ks

### Na bylinky - GÉL



Kód	balenie	m. j.
<b>B1305</b>	250 ml	ks

### Lesk na listy



Kód	balenie	m. j.
<b>B082</b>	250 ml	ks

## Kapka hnojivo na balkónové rastliny 1 l



Kód	balenie	m. j.
6358	1 l	ks

## Kapka hnojivo na ibišteky a oleandre 0,5 l



Kód	balenie	m. j.
6361	0,5 l	ks

Kapka hnojivo na izbové rastliny kvitnúce  
0,5 l

Kód	balenie	m. j.
6353	0,5 l	ks

Kapka hnojivo na izbové rastliny nekvitnúce  
0,5 l

Kód	balenie	m. j.
6355	0,5 l	ks

## Kapka hnojivo na kaktusy a sukulenty 0,2 l



Kód	balenie	m. j.
6374	0,2 l	ks

## Kapka hnojivo na na palmy, juky, dracény 0,5 l



Kód	balenie	m. j.
6360	0,5 l	ks

## Kapka hnojivo na orchideje a bromélie 0,2 l



Kód	balenie	m. j.
6371	0,2 l	ks

## Kapka hnojivo na ruže 0,5 l



Kód	balenie	m. j.
6368	0,5 l	ks

## Kapka hnojivo na surfínie a petúnie 0,5 l



Kód	balenie	m. j.
6366	0,5 l	ks

## Kapka hnojivo na trávniky 0,5 l



Kód	balenie	m. j.
6370	0,5 l	ks

## HNOJIVÁ

### Kapka

#### Kapka hnojivo univerzálne 0,5 l



Kód	balenie	m. j.
<b>6362</b>	0,5 l	ks

#### Kapka hnojivo univerzálne 1 l



Kód	balenie	m. j.
<b>6363</b>	1 l	ks

#### Kapka hnojivo na muškáty 1 l



Kód	balenie	m. j.
<b>6365</b>	1 l	ks

#### Kapka hnojivo na citrusy 0,2 l



Kód	balenie	m. j.
<b>6375</b>	0,2 l	ks

### Hoštické hnojivo

#### Hoštické hnojivo na rododendrony a azalky 0,5 l s guánom



Kód	balenie	m. j.
<b>6385</b>	0,5 l	ks

#### Hoštické hnojivo na paradajky a papriky 1 l s guánom



Kód	balenie	m. j.
<b>6382</b>	1 l	ks

#### Hoštické hnojivo na uhorky a cukety 0,5 l s guánom



Kód	balenie	m. j.
<b>6383</b>	0,5 l	ks

#### Hoštické prírodné hnojivo na čučoriedky 0,5 l s guánom



Kód	balenie	m. j.
<b>6380</b>	0,5 l	ks

## NPK 15-10-10



Kód	balenie	m. j.
70003	5 kg	ks
70001	25 kg	ks

NPK 15-10-10

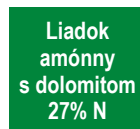
Liadok amónny  
s dolomitom 27% N

Kód	balenie	m. j.
70183	5 kg	ks
70186	25 kg	ks

## Močovina 46% N



Kód	balenie	m. j.
70152	25 kg	ks
70154	5 kg	ks

46% dusíka, bired max 0,6%

## Cererit NPK 8-13-11+ME



Kód	balenie	m. j.
70063	5 kg	ks
70060	25 kg	ks

## Draselná soľ granulát 60% KCl



Kód	balenie	m. j.
70191	25 kg	ks

obsah draslíka 60 %

## Síran draselný prášok



Kód	balenie	m. j.
74650	25 kg	ks

## Ducanit dusičnan vápenatý



Kód	balenie	m. j.
74310	25 kg	ks

15,5% N 26,3% CaO

## Dusíkaté vápno



Kód	balenie	m. j.
70012	1 kg	ks
70013	2,5 kg	ks
7001400	20 kg	ks

vápno 50%, dusík 20%

## YARA hnojivo

## Yara Krista-K Plus dusičnan draselný



Kód	balenie	m. j.
72200	2 kg	ks

46% K<sub>2</sub>O 13,5% NO<sub>3</sub>

## YarLiva Calcinit dusičnan vápenatý



Kód	balenie	m. j.
72300	2 kg	ks

15,5%N 19%Ca

## YaraVita Tenso Coctail



Kód	balenie	m. j.
74700	1 kg	ks

B,Ca,Cu,Fe,Mn,Mo,Zn

## HNOJIVÁ

### Yara - vodorozpustné kryštalické

#### Ferticare I



Kód	balenie	m. j.	kart.
<b>71000</b>	2 kg	ks	7

14-11-25+ME

#### Ferticare II



Kód	balenie	m. j.	kart.
<b>71100</b>	2 kg	ks	6

24-8-16+ME

#### Ferticare III



Kód	balenie	m. j.	kart.
<b>71200</b>	2 kg	ks	7

10-5-26+ME

#### Ferticare Starter



Kód	balenie	m. j.	kart.
<b>71500</b>	2 kg	ks	7

15-30-15+ME

### Engo - vodorozpustné kryštalické

#### Na kvitnúce rastliny



Kód	balenie	m. j.
<b>70400</b>	500 g	ks

15+11+29

#### Na izbové rastliny



Kód	balenie	m. j.
<b>70401</b>	500 g	ks

20+10+20

#### Na úpravu tvrdej vody a dokvitanie



Kód	balenie	m. j.
<b>70402</b>	500 g	ks

18+10+18

#### Na previslé petúnie



Kód	balenie	m. j.
<b>70404</b>	500 g	ks

20+20+20+Fe

#### Na dreviny a kríky



Kód	balenie	m. j.
<b>70406</b>	1000 g	ks

#### Prowen Winners - 5-6M na záhony



Kód	balenie	m. j.
<b>70407</b>	500 g	ks

## Na kvety



Kód	balenie	m. j.
<b>70900</b>	100 g	ks
<b>70910</b>	500 g	ks

## Na kvety



Kód	balenie	m. j.
<b>70920</b>	2 kg	ks

## Na trávnik



## Jar - Leto

Kód	balenie	m. j.
<b>70965</b>	0,95 l	ks

8-3-10+3MgO

## Na trávnik - náplň



## Jar - Leto

Kód	balenie	m. j.
<b>70966</b>	0,95 l	ks

## Ostatné hnojivá

## Ferrovit



Kód	balenie	m. j.
<b>81710</b>	1 l	ks
<b>81715</b>	5 l	ks
<b>81720</b>	10 l	ks

## Harmavit špeciál



Kód	balenie	m. j.
<b>82209</b>	0,5 l	ks
<b>82210</b>	1 l	ks
<b>82211</b>	5 l	ks
<b>82212</b>	10 l	ks

## Síra SK 520



Kód	balenie	m. j.
<b>81706</b>	1 l	ks

## Fetrilon 13% Fe chelátové železo



Kód	balenie	m. j.
<b>76710</b>	1 kg	ks

## ALLIVIT - Práškové hnojivo na cibuľoviny



Kód	balenie	m. j.
<b>82220</b>	0,5 kg	ks

## AGRICALMAG



Kód	balenie	m. j.
<b>82215</b>	1 l	ks

CaO 8,5% + MgO 1% + N 5% + bór

## Darina 4M



Kód	balenie	m. j.
<b>81183</b>	0,5 l	ks
<b>81182</b>	1 l	ks

## Zelená skalica

odstránenie machu v trávniku



Kód	balenie	m. j.
<b>84730</b>	1 kg	ks

## Modrá skalica

obsah medi - min. 23%



Kód	balenie	m. j.
<b>84740</b>	0,5 kg	ks

## Sport

**Zloženie:**

10 % Kostrava červená trstnatá CASANOVA,  
10 % Lipnica lúčna GEISHA,  
40 % Mätonoh trváci DOUBLE,  
5 % Kostrava ovčia RIDU,  
35 % Kostrava červená MAXIMA 1.

Kód	balenie	m. j.
<b>990200</b>	1 kg	ks
<b>990210</b>	7,5 kg	ks
<b>990212</b>	20 kg	ks

## Ornamental

**Zloženie:**

10 % Mätonoh trváci DOUBLE,  
50 % Kostrava trstovníkovitá STARLETT,  
30 % Kostrava červená MAXIMA 1,  
10 % Lipnica lúčna GEISHA.

Kód	balenie	m. j.
<b>990300</b>	1 kg	ks
<b>990310</b>	7,5 kg	ks
<b>990311</b>	20 kg	ks

## Shadow

**Zloženie:**

15 % Kostrava červená krátkovýbežkatá  
Archibal/GREENLIGHT,  
50 % Kostrava červená MAXIMA 1,  
5 % Kostrava ovčia RIDU,  
25 % Mätonoh trváci DOUBLE,  
5 % Lipnica pospolitá DASAS.

Kód	balenie	m. j.
<b>990420</b>	1 kg	ks
<b>990430</b>	7,5 kg	ks

## Waterless

**Zloženie:**

80 % Kostrava trstovníkovitá EYECANDY,  
10 % Lipnica lúčna GEISHA,  
10 % Mätonoh trváci DOUBLE.

Kód	balenie	m. j.
<b>990400</b>	1 kg	ks
<b>990410</b>	7,5 kg	ks
<b>990412</b>	20 kg	ks

## Easy Green

**Zloženie:**

35 % Mätonoh trváci DOUBLE,  
5 % Lipnica lúčna GEISHA,  
12 % Kostrava červená krátkovýbežkatá  
PINAFORE,  
45 % Kostrava červená MAXIMA 1,  
3 % MicroClover Ďateľina plazivá.

Kód	balenie	m. j.
<b>990500</b>	1 kg	ks
<b>990510</b>	7,5 kg	ks

## Mini

**Zloženie:**

10 % Lipnica lúčna GEISHA,  
30 % Kostrava červená MAXIMA 1,  
20 % Kostrava červená trstnatá CASANOVA,  
20 % Kostrava ovčia RIDU,  
20 % Mätonoh trváci DOUBLE.

Kód	balenie	m. j.
<b>990450</b>	1 kg	ks
<b>990460</b>	7,5 kg	ks
<b>990454</b>	20 kg	ks

## Grass Fix

**Zloženie:**

60 % Mätonoh trváci DOUBLE,  
30 % Kostrava červená MAXIMA 1,  
10 % Lipnica lúčna GEISHA.

Kód	balenie	m. j.
<b>990550</b>	1 kg	ks
<b>990560</b>	7,5 kg	ks

## Perfect Pitch

**Zloženie:**

60 % Mätonoh trváci QUICK ACTION,  
30 % Mätonoh trváci,  
10 % Lipnica lúčna.

Kód	balenie	m. j.
<b>990667</b>	2,5 kg	ks

**SportProfi****Zloženie:**

20 % Lipnica lúčna CONNI,  
20 % Lipnica lúčna JULIUS,  
20 % Lipnica lúčna GEISHA, YVETTE,  
20 % Mätonoh trváci DOUBLE,  
10 % Mätonoh trváci MONROE,  
10 % Mätonoh trváci DUPARC.

Kód	balenie	m. j.
<b>990601</b>	20 kg	ks

**Universal****Zloženie:**

10 % Lipnica lúčna BALIN, EVORA,  
30 % Mätonoh trváci BELIDA,  
20 % Mätonoh trváci ESQUIRE,  
20 % Kostrava červená dl. výbežkatá  
MAXIMA 1,  
20 % Mätonoh trváci DOUBLE.

Kód	balenie	m. j.
<b>990611</b>	20 kg	ks

**NDS R1 technická zmes****Zloženie:**

15 % Mätonoh trváci,  
55 % Kostrava červená,  
15 % Kostrava ovčia,  
15 % Lipnica lúčna.

Kód	balenie	m. j.
<b>990631</b>	20 kg	ks

**Park****Zloženie:**

10 % Lipnica lúčna BALIN, EVORA,  
30 % Mätonoh trváci ESQUIRE,  
35 % Kostrava červená dl. výbežkatá  
MAXIMA 1,  
25 % Kostrava červená trsnatá FIDELIO.

Kód	balenie	m. j.
<b>990635</b>	20 kg	ks

**Dosev a regenerácia****Zloženie:**

20 % Mätonoh trváci GREENWAY,  
30 % Mätonoh trváci DOUBLE,  
30 % Mätonoh trváci ESQUIRE,  
20 % Mätonoh trváci DUPARC.

Kód	balenie	m. j.
<b>990639</b>	20 kg	ks

## Water Saver



Kód	balenie	m. j.
<b>149021</b>	5 kg	ks
<b>149010</b>	15 kg	ks

## Rapide



Kód	balenie	m. j.
<b>149290</b>	5 kg	ks

## RPR Lawn



Kód	balenie	m. j.
<b>149070</b>	5 kg	ks
<b>149060</b>	15 kg	ks

## Supersport



Kód	balenie	m. j.
<b>14912</b>	5 kg	ks

## Prosoil



Kód	balenie	m. j.
<b>14934</b>	5 kg	ks

## SOS Lawn Repair



Kód	balenie	m. j.
<b>149330</b>	5 kg	ks

## Shadow &amp; sun



Kód	balenie	m. j.
<b>149280</b>	5 kg	ks



**Kvitnúca lúka Blumenwiese**

Kód	balenie	m. j.
<b>9906800</b>	10 kg	ks

Výdatnosť 600 - 800 m<sup>2</sup>**Zloženie:**

**Trávy 85%:** Bromus erectus 5%, Festuca ovina 15%, Festuca rubra 10%, Festuca rubra ubra 30%, Phleum pratense 5%, Poa pratensis 5%, Leguminosae 5%, Agrostis stolonifera 5%, Arrhenatherum elatius 5%.

**Byliny 15%:** Achillea millefolium, Anthemis tinctoria, Aquilegia vulgaris, Bellis perennis, Calendula officinalis, Campanula carpatica, Campanula glomerata, Campanula rotund, Centaurea cyanus, Centaurea jacea, Centaurea scabiosa, Chrysanthemum carinatum, Chrysanthemum coron, Chrysanthemum segetum, Coreopsis tinct, Daucus carota, Dianthus carthusianorum, Dianthus deltoides, Digitalis purpurea, Eschscholzia californica, Galium mollugo, Galium verum, Hypericum perforatum, Knautia arvensis, Leucanthemum vulg, Lychnis flos cuculi, Nigella sativa, Papaver rhoeas, Pimpinella saxifraga, Plantago lanceolata, Potentilla recta, Prunella vulgaris, Sanguisorba minor, Salvia pratensis, Thymus serpyllum.

**Trávobylinná lúka KLASIK**

Kód	balenie	m. j.
<b>990690</b>	1 kg	ks

**Zloženie:**

**Trávy 90%:** Agrostis capillaris 3%, Agrostis gigantea 2%, Anthoxanthum odoratum 1%, Arrhenatherum elatior 5%, Festuca pratensis 9%, Festuca rubra commutata 10%, Festuca rubra rubra 15%, Festuca rubra trichophylla 6%, Festuca trachyphylla 18%, Lolium perenne 2%, Phleum pratense 8%, Poa pratensis 11%.

**Byliny 7,3%:** Agrimonia eupatoria 0,6%, Achillea millefolium 0,3%, Anthemis tinctoria 0,5%, Carum carvi 0,2%, Centaurea jacea 0,4%, Daucus carota 0,1%, Galium album 0,3%, Hypericum perforatum 0,4%, Leontodon autumnalis 0,1%, Leontodon hispidus 0,1%, Leucanthemum vulgare 1,6%, Malva moschata 0,4%, Matricaria chamomilla 0,2%, Origanum vulgare 0,4%, Papaver rhoeas 0,2%, Plantago lanceolata 0,2%, Salvia pratensis 0,8%, Sanguisorba minor 0,5%.

**Ďatelínoviny 2,7%:** Anthyllis vulneraria 0,5%, Lotus corniculatus 0,8%, Medicago lupulina 0,2%, Onobrychis viciifoli 1%, Trifolium pratense 0,2%.

Odporúčaný výsev: 5 - 8 g/m<sup>2</sup> (1 kg = 125 - 200 m<sup>2</sup>).**Kvetná lúka Naturgarden**

Kód	balenie	m. j.
<b>990695</b>	200 g	ks

**Zloženie:**

**Trávy 92%:** Agrostis gigantea 4%, Agrostis capillaris 1%, Alopecurus pratensis 4%, Cynosurus cristatu 10%, Festuca rubra commutata 12%, Festuca rubra rubra 30%, Festuca rubra trichophylla 18%, Lolium perenne 3%, Phleum bertolonii 6%, Poa pratensis 4%.

**Byliny 7,25%:** Achillea millefolium 0,05%, Agrimonia procera 0,25%, Anthemis tinctoria 0,7%, Carum carvi 0,15%, Centaurea jacea 0,3%, Daucus carota 0,1%, Dianthus carthusianorum 0,5%, Galium album 0,3%, Hypericum perforatum 0,3%, Hyssopus officinalis 0,2%, Leontodon autumnalis 0,1%, Leucanthemum vulgare 1,2%, Linum usitatissimum 0,2%, Malva moschata 0,4%, Matricaria chamomilla 0,05%, Plantago lanceolata 0,05%, Potentilla recta 0,3%, Salvia pratensis 1,2%, Sanguisorba minor 0,15%, Silene dioica 0,3%, Silene vulgaris 0,2%, Silybum marianum 0,05%.

**Letničky 0,35%:** Agrostemma githago 0,15%, Calendula officinalis 0,15%, Papaver rhoeas 0,05%.

**Lucerna siata C1 ARTEMIS**

Kód	balenie	m. j.
<b>149430</b>	500 g	ks

**Ďatelina lúčna C1 SPURT/AGIL**

Kód	balenie	m. j.
<b>149390</b>	250 g	ks

**DLF LOUKA 4 - na seno, pasenie koní, ovcí**

Kód	balenie	m. j.
<b>990703</b>	5 kg	ks
<b>990705</b>	10 kg	ks

## Pletivo pod trávnik

### Pletivo Polynet 301R PE

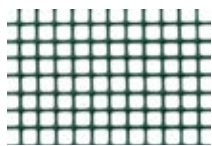

Kód	balenie	m. j.
<b>28710</b>	50 m	ks

zelené/čierne, oká 10 x 10 mm

### Pletivo pod trávnik 45 g

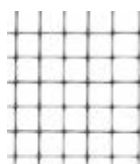

**T.GARDEN**

Kód	balenie	m. j.
<b>28758</b>	1x 20 m	ks
<b>28759</b>	1x 50 m	ks
<b>28755</b>	1x 200 m	ks
<b>28756</b>	2x 200 m	ks

čierne, oká 15 x 15 mm

### Pletivo pod trávnik 58 g

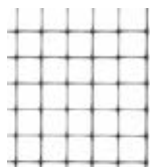

Kód	balenie	m. j.
<b>28721</b>	1x 200 m	ks
<b>28722</b>	2x 200 m	ks

čierne, oká 18 x 18 mm

### Pletivo pod trávnik Pro 60 g

**NEW**

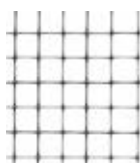

Kód	balenie	m. j.
<b>28765</b>	1x 50 m	ks
<b>28771</b>	2x 100 m	ks
<b>28767</b>	1x 200 m	ks

čierne, oká 15 x 15 mm

## Okraje trávnik

### Obruba zatĺkacia



Kód	farba	rozmery	m. j.
<b>14030</b>	zelená	12 x 15 cm	ks
<b>14031</b>	hnedá	12 x 15 cm	ks

### Plastový lem - obruba



Kód	výška	balenie	m. j.
<b>11223344</b>	15 cm	25 m	ks

### Okraj trávnik



Kód	výška	dĺžka	m. j.
<b>14010</b>	10 cm	9 m	ks
<b>14015</b>	15 cm	9 m	ks
<b>14020</b>	20 cm	9 m	ks

### Trávníkový lem



Kód	výška	dĺžka	m. j.	balenie
<b>140110</b>	9,5 cm	6 m	ks	12

### Záhradný obrubník flex - set + 20 klincov



**T.GARDEN**

Kód	výška	dĺžka	m. j.	balenie
<b>150451</b>	3,8 cm	10 m	ks	1

## Okraje trávnik

### Ekobrim lišta



Kód	výška	m. j.
<b>14001</b>	5 cm	ks

### Plastový kliniec k záhradným obrubníkom



Kód	dĺžka	použitie pre	balenie	m. j.
<b>14003</b>	24 mm	Ekobrim a Nízky	50 ks	ks
<b>140035</b>	25 mm	všetky	50 ks	ks

### Príchytky na pletivo pod trávu 10 cm



hlavička 3 cm

Kód	balenie	m. j.
<b>28711</b>	100 ks	bal.
<b>28713</b>	300 ks	bal.
<b>28715</b>	500 ks	bal.

### Kolík k obrubníku ALU L



Kód	rozmery	m. j.
<b>140018</b>	30 x 2,3 x 1,1 cm pozink	ks

## Záhradné obrubníky

### GARDEN 45



Kód	výška	dĺžka	šírka	m. j.	balenie
<b>1400450</b>	45 mm	1025 mm	80 mm	ks	2

### NÍZKY



Kód	výška	dĺžka	šírka	m. j.	balenie
<b>140045</b>	45 mm	1025 mm	75 mm	ks	16

### STREDNÝ, VYSOKÝ



Kód	výška	dĺžka	šírka	m. j.	balenie
<b>140058</b>	58 mm	1025 mm	75 mm	ks	12
<b>140078</b>	78 mm	1025 mm	75 mm	ks	8

### Obrubník ALU L



NEW

Kód	výška	dĺžka	šírka	m. j.	balenie
<b>140017</b>	44,5 mm	1200 mm	50 mm	ks	3

### Obrubník Corten L



NEW

Kód	výška	dĺžka	šírka	m. j.	balenie
<b>140016</b>	50 mm	2000 mm	50 mm	ks	20

## Zatrávňovacie panely

### Zatrávňovací panel čierny 0,25 m<sup>2</sup>



Kód	rozмеры	m. j.
<b>14004590</b>	500 x 500 x 40 mm	ks

### Zatrávňovací panel zelený 0,876 m<sup>2</sup>

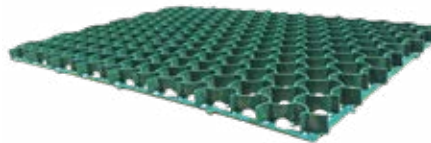

Kód	rozмеры	m. j.
<b>14004</b>	1160 x 755 x 38 mm	ks

### Stabilizačná rohož na štrk 0,9 m<sup>2</sup>

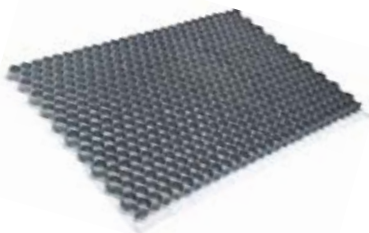

Kód	rozмеры	m. j.	farba
<b>140061</b>	1176 x 764 x 32 mm	ks	šedá
<b>1400610</b>	1176 x 764 x 32 mm	ks	biela

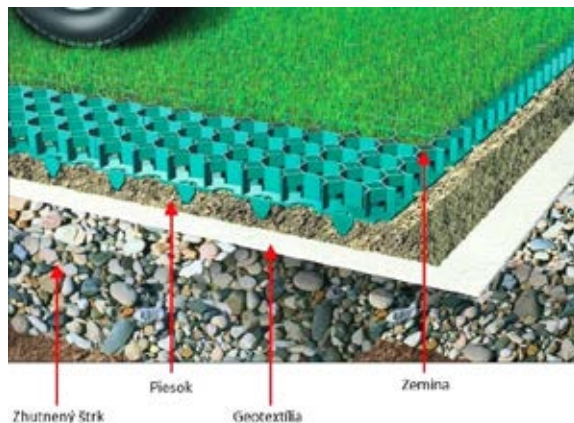

## Umelý trávnik

### Umelý trávnik GREEN 35



Kód	popis	m. j.
<b>14083</b>	2 x 25 m, olivová, výška vlasu 35 mm	m <sup>2</sup>

### Umelý anglický trávnik 20



Kód	popis	m. j.
<b>14088</b>	2 x 25 m, výška vlasu 20 mm	m <sup>2</sup>
<b>14089</b>	4 x 25 m, výška vlasu 20 mm	m <sup>2</sup>

### Samolepiaca páska S100



Kód	popis	m. j.
<b>14095</b>	15 cm x 20 m, na umelý trávnik	ks



NEW



NEW

Kód	popis	m. j.
<b>1900300</b>	Multi kompostér 300 l čierny	ks

Kód	popis	m. j.
<b>1900480</b>	Kompostér 480 l čierny	ks



NEW



NEW

Kód	popis	m. j.
<b>1900740</b>	Kompostér 740 l čierny	ks

Kód	popis	m. j.
<b>19001000</b>	Kompostér 1000 l čierny	ks

## Odlahčené kvetináče MODIFORM

## Kvetináče



Kód	názov	farba	rozmer	balenie/pal.
<b>1007002167</b>	P085574	Royal grey	8,5 cm 5° M 285 cc	2x 27650 = 55300 ks
<b>1057002133</b>	P09568	Royal grey	9 cm 5° L 300 cc	2x 23400 = 46800 ks
<b>1107002425</b>	P09568	Terakota	9 cm 5° L 300 cc	2x 23400 = 46800 ks
<b>1207002172</b>	P09587	Royal grey	9 cm 5° H 350 cc	2x 22800 = 45600 ks
<b>1307002440</b>	P09587	Terakota	9 cm 5° H 350 cc	2x 22800 = 45600 ks
<b>1807002176</b>	P10576	Royal grey	10 cm 5° 400 cc	2x 18150 = 36300 ks
<b>1407002135</b>	P105579	Royal grey	10,5 cm 5° L 470 cc	2x 16112 = 32224 ks
<b>1507002127</b>	P105579	Terakota	10,5 cm 5° L 470 cc	2x 16112 = 32224 ks
<b>1607002142</b>	P105590	Royal grey	10,5 cm 5° HB 11V 510 cc	2x 15476 = 30952 ks
<b>1707002270</b>	P105590	Terakota	10,5 cm 5° HB 11V 510 cc	2x 15476 = 30952 ks
<b>1907002047</b>	P12589	Royal grey	12 cm 5° L 690 cc	2x 12118 = 24236 ks
<b>2007002633</b>	P12589	Terakota	12 cm 5° L 690 cc	2x 12118 = 24236 ks
<b>2107002141</b>	P12889	Royal grey	12 cm 8° L 650 cc	2x 12118 = 24236 ks
<b>2207002271</b>	P12889	Terakota	12 cm 8° L 650 cc	2x 12118 = 24236 ks
<b>2307002128</b>	P13596	Royal grey	13 cm 5° L 885 cc	2x 9240 = 18480 ks
<b>2407002364</b>	P13596	Terakota	13 cm 5° L 885 cc	2x 9240 = 18480 ks
<b>2507002195</b>	P145109	Royal grey	14 cm 5° L 1100 cc	2x 7440 = 14880 ks
<b>2607002258</b>	P145C121	Terakota	14 cm 5° 1300 cc	2x 7440 = 14880 ks
<b>2707002200</b>	P155124	Royal grey	15 cm 5° 1500 cc	2x 5880 = 11760 ks
<b>2807002134</b>	P175128	Royal grey	17 cm 5° L 2000 cc	2x 3978 = 7956 ks
<b>2907002574</b>	P175128	Terakota	17 cm 5° L 2000 cc	2x 3978 = 7956 ks
<b>3007002129</b>	P195149	Royal grey	19 cm 5° L 3000 cc	2x 3072 = 6144 ks
<b>3107002580</b>	P195149	Terakota	19 cm 5° L 3000 cc	2x 3072 = 6144 ks
<b>3207002205</b>	SQ070765-H8	Royal grey	7 x 7 L BX 190 cc	2x 41664 = 83328 ks
<b>3307002207</b>	SQ070780-H8	Royal grey	7 x 7 H BX 228 cc	2x 40320 = 80640 ks
<b>3407002209</b>	SQ080870-H8	Royal grey	8 x 8 L BX 275 cc	2x 20736 = 41472 ks
<b>3507002770</b>	SQ080880-H8	Dark green	8 x 8 H BX 306 cc	2x 20448 = 40896 ks



Kód	farba	rozmer	balenie/pal.
<b>46124001</b>	čierny	7 x 7 x 6,2 cm/200 cc	2016 ks x 40 kartónov = 80640 ks/Hpal
<b>21021101</b>	čierny	7 x 7 x 8 cm PP/230 cc	2160 ks x 40 kartónov = 86400 ks/Hpal
<b>46714001</b>	čierny	8 x 8 x 7cm PN/300 cc	239 ks x 36 kartónov = 44604 ks/Hpal
<b>46774001</b>	čierny	8 x 8 x 8 cm PN/400 cc	1218 ks x 36 kartónov = 43848 ks/Hpal
<b>46884001</b>	čierny	9 x 9 x 8 cm SQ /480 cc	1104 ks x 30 kartónov = 33120 ks/Hpal
<b>46904001</b>	čierny	9 x 9 x 9,5 cm SQ /590 cc	1008 ks x 30 kartónov = 30240 ks/Hpal



Kód	rozmer	farba	balenie/pal.
2208506501	d 8,5 cm/5°/h 6,5 cm/220 cc	čierno-šedý	2150 ks x 18 kart. = 38700 ks/H pal
2208506502	d 8,5 cm/5°/h 6,5 cm/220 cc	terakota	2150 ks x 18 kart. = 38700 ks/H pal
2208506503	d 8,5 cm/5°/h 6,5 cm/220 cc	biely	2150 ks x 18 kart. = 38700 ks/H pal
2208506504	d 8,5 cm/5°/h 6,5 cm/220 cc	šedý NIR	2150 ks x 18 kart. = 38700 ks/H pal
2209006801	d 9,0 cm/5°/h 6,8 cm/300 cc	čierno-šedý	1920 ks x 18 kart. = 34560 ks/H pal
2209006802	d 9,0 cm/5°/h 6,8 cm/300 cc	terakota	1920 ks x 18 kart. = 34560 ks/H pal
2209006803	d 9,0 cm/5°/h 6,8 cm/300 cc	biely	1920 ks x 18 kart. = 34560 ks/H pal
2209006804	d 9,0 cm/5°/h 6,8 cm/300 cc	šedý NIR	1920 ks x 18 kart. = 34560 ks/H pal
2210007601	d 10,0 cm/5°/h 7,6 cm/410 cc	čierno-šedý	1472 ks x 18 kart. = 26496 ks/H pal
2210007602	d 10,0 cm/5°/h 7,6 cm/410 cc	terakota	1472 ks x 18 kart. = 26496 ks/H pal
2210007603	d 10,0 cm/5°/h 7,6 cm/410 cc	biely	1472 ks x 18 kart. = 26496 ks/H pal
2210007604	d 10,0 cm/5°/h 7,6 cm/410 cc	šedý NIR	1472 ks x 18 kart. = 26496 ks/H pal
2210508001	d 10,5 cm/5°/h 8,0 cm/460 cc	čierno-šedý	1395 ks x 18 kart. = 25110 ks/H pal
2210508002	d 10,5 cm/5°/h 8,0 cm/460 cc	terakota	1395 ks x 18 kart. = 25110 ks/H pal
2210508003	d 10,5 cm/5°/h 8,0 cm/460 cc	biely	1395 ks x 18 kart. = 25110 ks/H pal
2210508004	d 10,5 cm/5°/h 8,0 cm/460 cc	šedý NIR	1395 ks x 18 kart. = 25110 ks/H pal
2210509201	d 10,5 cm/5°/h 9,2 cm/510 cc	čierno-šedý	1260 ks x 18 kart. = 22680 ks/H pal
2210509202	d 10,5 cm/5°/h 9,2 cm/510 cc	terakota	1260 ks x 18 kart. = 22680 ks/H pal
2210509203	d 10,5 cm/5°/h 9,2 cm/510 cc	biely	1260 ks x 18 kart. = 22680 ks/H pal
2210509204	d 10,5 cm/5°/h 9,2 cm/510 cc	šedý NIR	1260 ks x 18 kart. = 22680 ks/H pal
2211008201	d 11,0 cm/5°/h 8,2 cm/500 cc	čierno-šedý	1118 ks x 18 kart. = 20124 ks/H pal
2211008202	d 11,0 cm/5°/h 8,2 cm/500 cc	terakota	1118 ks x 18 kart. = 20124 ks/H pal
2211008203	d 11,0 cm/5°/h 8,2 cm/500 cc	biely	1118 ks x 18 kart. = 20124 ks/H pal
2211008204	d 11,0 cm/5°/h 8,2 cm/500 cc	šedý NIR	1118 ks x 18 kart. = 20124 ks/H pal
2211009801	d 11,0 cm/5°/h 9,8 cm/640 cc	čierno-šedý	988 ks x 18 kart. = 17784 ks/H pal
2211009802	d 11,0 cm/5°/h 9,8 cm/640 cc	terakota	988 ks x 18 kart. = 17784 ks/H pal
2211009803	d 11,0 cm/5°/h 9,8 cm/640 cc	biely	988 ks x 18 kart. = 17784 ks/H pal
2211009804	d 11,0 cm/5°/h 9,8 cm/640 cc	šedý NIR	988 ks x 18 kart. = 17784 ks/H pal
2211709001	d 11,7 cm/5°/h 9,0 cm/660 cc	čierno-šedý	984 ks x 18 kart. = 17712 ks/H pal
2211709002	d 11,7 cm/5°/h 9,0 cm/660 cc	terakota	984 ks x 18 kart. = 17712 ks/H pal
2211709003	d 11,7 cm/5°/h 9,0 cm/660 cc	biely	984 ks x 18 kart. = 17712 ks/H pal
2211709004	d 11,7 cm/5°/h 9,0 cm/660 cc	šedý NIR	984 ks x 18 kart. = 17712 ks/H pal
2211709005	d 11,7 cm/5°/h 9,0 cm/660 cc	VIOLET	984 ks x 18 kart. = 17712 ks/H pal
2211709006	d 11,7 cm/5°/h 9,0 cm/660 cc	GREEN	984 ks x 18 kart. = 17712 ks/H pal
2211709007	d 11,7 cm/5°/h 9,0 cm/660 cc	PINK	984 ks x 18 kart. = 17712 ks/H pal
2212009001	d 12,0 cm/5°/h 9,0 cm/720 cc	čierno-šedý	810 ks x 18 kart. = 14580 ks/H pal



## Odlahčené kvetináče Floser

## Kvetináče



Kód	rozmer	farba	balenie/pal.
<b>2212009002</b>	d 12,0 cm/5°/h 9,0 cm/720 cc	terakota	810 ks x 18 kart. = 14580 ks/H pal
<b>2212009003</b>	d 12,0 cm/5°/h 9,0 cm/720 cc	biely	810 ks x 18 kart. = 14580 ks/H pal
<b>2212009004</b>	d 12,0 cm/5°/h 9,0 cm/720 cc	šedý NIR	810 ks x 18 kart. = 14580 ks/H pal
<b>2213009801</b>	d 13,0 cm/5°/h 9,8 cm/850 cc	čierno-šedý	612 ks x 18 kart. = 11016 ks/H pal
<b>2213009802</b>	d 13,0 cm/5°/h 9,8 cm/850 cc	terakota	612 ks x 18 kart. = 11016 ks/H pal
<b>2213009803</b>	d 13,0 cm/5°/h 9,8 cm/850 cc	biely	612 ks x 18 kart. = 11016 ks/H pal
<b>2213009804</b>	d 13,0 cm/5°/h 9,8 cm/850 cc	šedý NIR	612 ks x 18 kart. = 11016 ks/H pal
<b>2214010901</b>	d 14,0 cm/5°/h 10,9 cm/1,0 l	čierno-šedý	55 ks x 256 = 14080 ks/H pal
<b>2214010902</b>	d 14,0 cm/5°/h 10,9 cm/1,0 l	terakota	55 ks x 256 = 14080 ks/H pal
<b>2214010903</b>	d 14,0 cm/5°/h 10,9 cm/1,0 l	biely	55 ks x 256 = 14080 ks/H pal
<b>2214010904</b>	d 14,0 cm/5°/h 10,9 cm/1,0 l	šedý NIR	55 ks x 256 = 14080 ks/H pal
<b>2315012001</b>	d 15,0 cm /5°/ h 12,0 cm/1,5 l	čierno-šedý	50 ks x 196 = 9800 ks/H pal
<b>2315012002</b>	d 15,0 cm /5°/ h 12,0 cm/1,5 l	terakota	50 ks x 196 = 9800 ks/H pal
<b>2315012003</b>	d 15,0 cm /5°/ h 12,0 cm/1,5 l	biely	50 ks x 196 = 9800 ks/H pal
<b>2315012004</b>	d 15,0 cm /5°/ h 12,0 cm/1,5 l	šedý NIR	50 ks x 196 = 9800 ks/H pal
<b>2317013301</b>	d 17,0 cm /5°/ h 13,3 cm/2,0 l	čierno-šedý	50 ks x 164 = 8200 ks/H pal
<b>2317013302</b>	d 17,0 cm /5°/ h 13,3 cm/2,0 l	terakota	50 ks x 164 = 8200 ks/H pal
<b>2317013303</b>	d 17,0 cm /5°/ h 13,3 cm/2,0 l	biely	50 ks x 164 = 8200 ks/H pal
<b>2317013304</b>	d 17,0 cm /5°/ h 13,3 cm/2,0 l	šedý NIR	50 ks x 164 = 8200 ks/H pal
<b>2319014801</b>	d 19,0 cm /5°/ h 14,8 cm/3,0 l	čierno-šedý	40 ks x 132 = 5280 ks/H pal
<b>2319014802</b>	d 19,0 cm /5°/ h 14,8 cm/3,0 l	terakota	40 ks x 132 = 5280 ks/H pal
<b>2319014803</b>	d 19,0 cm /5°/ h 14,8 cm/3,0 l	biely	40 ks x 132 = 5280 ks/H pal
<b>2319014804</b>	d 19,0 cm /5°/ h 14,8 cm/3,0 l	šedý NIR	40 ks x 132 = 5280 ks/H pal
<b>2319014805</b>	d 19,0 cm /5°/ h 14,8 cm/3,0 l	VIO LET	40 ks x 132 = 5280 ks/H pal
<b>2323018001</b>	d 23,0 cm /5°/ h 18,0 cm/5,0 l	čierno-šedý	40 ks x 92 = 3680 ks/H pal
<b>2323018002</b>	d 23,0 cm /5°/ h 18,0 cm/5,0 l	terakota	40 ks x 92 = 3680 ks/H pal
<b>2323018003</b>	d 23,0 cm /5°/ h 18,0 cm/5,0 l	biely	40 ks x 92 = 3680 ks/H pal
<b>2323018004</b>	d 23,0 cm /5°/ h 18,0 cm/5,0 l	šedý NIR	40 ks x 92 = 3680 ks/H pal
<b>2326021101</b>	d 26,0 cm /5°/ h 21,1 cm/7,5 l	čierno-šedý	30 ks x 68 = 2040 ks/H pal
<b>2326021102</b>	d 26,0 cm /5°/ h 21,1 cm/7,5 l	terakota	30 ks x 68 = 2040 ks/H pal
<b>2326021103</b>	d 26,0 cm /5°/ h 21,1 cm/7,5 l	biely	30 ks x 68 = 2040 ks/H pal
<b>2326021104</b>	d 26,0 cm /5°/ h 21,1 cm/7,5 l	šedý NIR	30 ks x 68 = 2040 ks/H pal
<b>2329022801</b>	d 29,0 cm /5°/ h 22,8 cm/10,0 l	čierno-šedý	25 ks x 56 = 1400 ks/H pal
<b>2329022802</b>	d 29,0 cm /5°/ h 22,8 cm/10,0 l	terakota	25 ks x 56 = 1400 ks/H pal
<b>2329022803</b>	d 29,0 cm /5°/ h 22,8 cm/10,0 l	biely	25 ks x 56 = 1400 ks/H pal
<b>2329022804</b>	d 29,0 cm /5°/ h 22,8 cm/10,0 l	šedý NIR	25 ks x 56 = 1400 ks/H pal



## Misky



Kód	rozmer	farba	balenie/pal.
<b>2217008501</b>	d 17,0 cm/h 8,5 cm/1,6 l	čierno-šedý	80 ks x 144 = 11520 ks/H pal
<b>2217008502</b>	d 17,0 cm/h 8,5 cm/1,6 l	terakota	80 ks x 144 = 11520 ks/H pal
<b>2217008503</b>	d 17,0 cm/h 8,5 cm/1,6 l	biely	80 ks x 144 = 11520 ks/H pal
<b>2217008504</b>	d 17,0 cm/h 8,5 cm/1,6 l	šedý NIR	80 ks x 144 = 11520 ks/H pal
<b>2219009501</b>	d 19,0 cm/h 9,5 cm/2,1 l	čierno-šedý	75 ks x 112 = 8400 ks/H pal
<b>2219009502</b>	d 19,0 cm/h 9,5 cm/2,1 l	terakota	75 ks x 112 = 8400 ks/H pal
<b>2219009503</b>	d 19,0 cm/h 9,5 cm/2,1 l	biely	75 ks x 112 = 8400 ks/H pal
<b>2219009504</b>	d 19,0 cm/h 9,5 cm/2,1 l	šedý NIR	75 ks x 112 = 8400 ks/H pal
<b>2221010501</b>	d 21,0 cm/h 10,5 cm/3,0 l (na chryzantémy)	čierno-šedý	60 ks x 92 = 5520 ks/H pal
<b>2221010502</b>	d 21,0 cm/h 10,5 cm/3,0 l (na chryzantémy)	terakota	60 ks x 92 = 5520 ks/H pal
<b>2221010503</b>	d 21,0 cm/h 10,5 cm/3,0 l (na chryzantémy)	biely	60 ks x 92 = 5520 ks/H pal
<b>2221010504</b>	d 21,0 cm/h 10,5 cm/3,0 l (na chryzantémy)	šedý NIR	60 ks x 92 = 5520 ks/H pal



## Kvetináč hranatý



Kód	rozmer	farba	balenie/pal.
<b>2309009501</b>	d 9,0 cm /5°/ h 9,5 cm/0,5 l	čierno-šedý	18 ks x 1376 = 24768 ks/H pal
<b>2309009502</b>	d 9,0 cm /5°/ h 9,5 cm/0,5 l	terakota	18 ks x 1376 = 24768 ks/H pal
<b>2309009503</b>	d 9,0 cm /5°/ h 9,5 cm/0,5 l	biely	18 ks x 1376 = 24768 ks/H pal
<b>2309009504</b>	d 9,0 cm /5°/ h 9,5 cm/0,5 l	šedý NIR	18 ks x 1376 = 24768 ks/H pal



## Závesný kvetináč



Kód	názov	farba	rozmer	balenie/pal.
<b>2221014401</b>	W21	čierno-šedý	d 21,0 cm/h 14,4 cm/3,0 l	40 ks x 160 = 5600 ks/ H pal
<b>2221014402</b>	W21	terakota	d 21,0 cm/h 14,4 cm/3,0 l	40 ks x 160 = 5600 ks/ H pal
<b>2221014403</b>	W21	biely	d 21,0 cm/h 14,4 cm/3,0 l	40 ks x 160 = 5600 ks/ H pal
<b>2221014404</b>	W21	šedý NIR	d 21,0 cm/h 14,4 cm/3,0 l	40 ks x 160 = 5600 ks/ H pal
<b>2223015401</b>	W23	čierno-šedý	d 23,0 cm/h 15,4 cm/4,0 l	40 ks x 115 = 4600 ks/ H pal
<b>2223015402</b>	W23	terakota	d 23,0 cm/h 15,4 cm/4,0 l	40 ks x 115 = 4600 ks/ H pal
<b>2223015403</b>	W23	biely	d 23,0 cm/h 15,4 cm/4,0 l	40 ks x 115 = 4600 ks/ H pal
<b>2223015404</b>	W23	šedý NIR	d 23,0 cm/h 15,4 cm/4,0 l	40 ks x 115 = 4600 ks/ H pal
<b>2225515801</b>	W25	čierno-šedý	d 25,5 cm/h 15,8 cm/5,0 l	60 ks x 54 = 3240 ks/ H pal
<b>2225515802</b>	W25	terakota	d 25,5 cm/h 15,8 cm/5,0 l	60 ks x 54 = 3240 ks/ H pal
<b>2225515803</b>	W25	biely	d 25,5 cm/h 15,8 cm/5,0 l	60 ks x 54 = 3240 ks/ H pal
<b>2225515804</b>	W25	šedý NIR	d 25,5 cm/h 15,8 cm/5,0 l	60 ks x 54 = 3240 ks/ H pal



LEN NA  
OBJEDNÁVKU

## Hák k závesnému kvetináču



Kód	názov	farba	rozmer	balenie/pal.
<b>2236003501</b>	Z36	čierno-šedý	d 3,5 cm/h 36,0 cm	20/500 ks x 18 = 9000 ks/H pal
<b>2236003502</b>	Z36	terakota	d 3,5 cm/h 36,0 cm	20/500 ks x 18 = 9000 ks/H pal
<b>2236003503</b>	Z36	biely	d 3,5 cm/h 36,0 cm	20/500 ks x 18 = 9000 ks/H pal
<b>2236003504</b>	Z36	šedý NIR	d 3,5 cm/h 36,0 cm	20/500 ks x 18 = 9000 ks/H pal
<b>2247003501</b>	Z46	čierno-šedý	d 3,5 cm/h 47,0 cm	20/500 ks x 18 = 9000 ks/H pal
<b>2247003502</b>	Z46	terakota	d 3,5 cm/h 47,0 cm	20/500 ks x 18 = 9000 ks/H pal
<b>2247003503</b>	Z46	biely	d 3,5 cm/h 47,0 cm	20/500 ks x 18 = 9000 ks/H pal
<b>2247003504</b>	Z46	šedý NIR	d 3,5 cm/h 47,0 cm	20/500 ks x 18 = 9000 ks/H pal

V prípade záujmu možno objednať aj iné farby.



LEN NA  
OBJEDNÁVKU

Kód	názov	rozmer	farba	balenie
<b>46958</b>	HP LUX WR	23/14,2 cm/3,5 l	zelený	1000 ks/pal
<b>46960</b>	HP LUX WR	23/14,2 cm/3,5 l	biely	1000 ks/pal
<b>46962</b>	HP LUX WR	23/14,2 cm/3,5 l	terakota	1000 ks/pal
<b>46600</b>	HP LUX WR	25/16,2 cm/5 l	zelený	1000 ks/pal
<b>46605</b>	HP LUX WR	25/16,2 cm/5 l	biely	1000 ks/pal
<b>46610</b>	HP LUX WR	25/16,2 cm/5 l	terakota	1000 ks/pal
<b>46630</b>	HP DECOR WR	27/18,5 cm/7 l	zelený	800 ks/pal
<b>46635</b>	HP DECOR WR	27/18,5 cm/7 l	biely	800 ks/pal
<b>46640</b>	HP DECOR WR	27/18,5 cm/7 l	terakota	800 ks/pal
<b>46660</b>	Hák	46 cm	zelený	400 ks/kartón
<b>46665</b>	Hák	46 cm	biely	400 ks/kartón
<b>46670</b>	Hák	46 cm	terakota	400 ks/kartón

## Závesné kvetináče SOPARCO



Kód	názov	rozmer	farba	balenie
<b>37140</b>	ONDINE 6 l+2 l	26,4 x 23,5 cm	borovicovo zelený	35 ks/kart, 16 kart/pal
<b>37150</b>	ONDINE 6 l+2 l	26,4 x 23,5 cm	béžový	35 ks/kart, 16 kart/pal
<b>37152</b>	ONDINE 6 l+2 l	26,4 x 23,5 cm	fu ksia	35 ks/kart, 16 kart/pal
<b>37154</b>	ONDINE 6 l+2 l	26,4 x 23,5 cm	zelený	35 ks/kart, 16 kart/pal
<b>37158</b>	ONDINE 6 l+2 l	26,4 x 23,5 cm	biely	35 ks/kart, 16 kart/pal
<b>37200</b>	25 NJ WR	25 x 15,4 cm 5(4,5) l	šedý	96 ks/kart, 12 kart/pal
<b>37202</b>	25 NJ WR	25 x 15,4 cm 5(4,5) l	fialový	96 ks/kart, 12 kart/pal
<b>37204</b>	25 NJ WR	25 x 15,4 cm 5(4,5) l	slivkovo-modrý	96 ks/kart, 12 kart/pal
<b>37206</b>	25 NJ WR	25 x 15,4 cm 5(4,5) l	fu ksia	96 ks/kart, 12 kart/pal
<b>37208</b>	25 NJ WR	25 x 15,4 cm 5(4,5) l	zelený	96 ks/kart, 12 kart/pal
<b>37210</b>	25 NJ WR	25 x 15,4 cm 5(4,5) l	červený	96 ks/kart, 12 kart/pal
<b>37216</b>	25 NJ WR	25 x 15,4 cm 5(4,5) l	šedo-hnedý	96 ks/kart, 12 kart/pal
<b>37220</b>	25 NJ WR	25 x 15,4 cm 5(4,5) l	borovicovo zelený	96 ks/kart, 12 kart/pal
<b>37222</b>	25 NJ WR	25 x 15,4 cm 5(4,5) l	biely	96 ks/kart, 12 kart/pal
<b>37160</b>	27 NJ WR	27 x 16,2 cm 6(5,6) l	šedý	96 ks/kart/12 kart/pal
<b>37162</b>	27 NJ WR	27 x 16,2 cm 6(5,6) l	fialový	96 ks/kart, 12 kart/pal
<b>37164</b>	27 NJ WR	27 x 16,2 cm 6(5,6) l	slivkovo-modrý	96 ks/kart, 12 kart/pal
<b>37166</b>	27 NJ WR	27 x 16,2 cm 6(5,6) l	fu ksia	96 ks/kart, 12 kart/pal
<b>37168</b>	27 NJ WR	27 x 16,2 cm 6(5,6) l	zelený	96 ks/kart, 12 kart/pal
<b>37170</b>	27 NJ WR	27 x 16,2 cm 6(5,6) l	červený	96 ks/kart, 12 kart/pal
<b>37176</b>	27 NJ WR	27 x 16,2 cm 6(5,6) l	šedo-hnedý	96 ks/kart, 12 kart/pal
<b>37180</b>	27 NJ WR	27 x 16,2 cm 6(5,6) l	borovicovo zelený	96 ks/kart, 12 kart/pal
<b>37182</b>	27 NJ WR	27 x 16,2 cm 6(5,6) l	biely	96 ks/kart, 12 kart/pal



Kód	názov	rozmer	farba	balenie
<b>46922</b>	LBCZ	2 l/17,6 cm/11,2 v	čierny	4680 ks/pal
<b>46924</b>	LBCZ	3 l/20 cm/12,7 v	čierny	3600 ks/pal
<b>46926</b>	LBCZ	4 l/22 cm/14,3 v	čierny	2300 ks/pal
<b>46928</b>	LBCZ	5 l/23,7 cm/15,4 v	čierny	1800 ks/pal
<b>46930</b>	LBCZ	7,5 l/27 cm/17,6 v	čierny	1520 ks/pal
<b>46932</b>	LBCZ	10 l/30 cm/19,4 v	čierny	1020 ks/pal
<b>45912</b>	LBCZ	12,0 l 32/20,7 cm 5°	čierny	900 ks/pal
<b>45915</b>	LBCZ	15,0 l 34/22,2 cm 5°	čierny	666 ks/pal
<b>45920</b>	LBCZ	20,0 l 38/24,7 cm 5°	čierny	520 ks/pal
<b>45925</b>	LBCZ	25,0 l 41/26,5 cm	čierny	420 ks/pal
<b>45927</b>	LBCZ	35,0 l 45,9/32 cm 5°	čierny	185 ks/pal



Kód	názov	rozmer	farba	balenie
<b>46876</b>	SBX	1,5 l/15 cm/12 v	čierny	6360 ks/pal
<b>46880</b>	SBX	2 l/17 cm/13,5 v	čierny	4620 ks/pal
<b>46884</b>	SBX	3 l/19 cm/15 v	čierny	3300 ks/pal
<b>46894</b>	SBX	4 l/21 cm/16 v	čierny	2484 ks/pal
<b>46896</b>	SBX	5 l/23 cm/18,3 v	čierny	2116 ks/pal
<b>46898</b>	SBX	7,5 l/26 cm/20,5 v	čierny	1120 ks/pal
<b>46900</b>	SBX	10 l/29 cm/22,9 v	čierny	980 ks/pal
<b>46902</b>	SBX	12 l/31cm/25,5 v	čierny	720 ks/pal
<b>46903</b>	SBX	15 l/32,7 cm/25,8 v	čierny	600 ks/pal



Kód	názov	rozmer	farba	balenie
<b>45929</b>	H-LSR	45,0 l 46/33,5 cm v 5°	čierny	150 ks/pal
<b>45930</b>	H-LSR	65,0 l 54/35 cm v 5°	čierny	120 ks/pal



Kód	názov	rozmer	farba
<b>45932</b>	Kontajner	90,0 l 67/35 cm v 8°	čierny



Kód	názov	rozmer	farba	balenie
<b>46864</b>	na ruže RP	2 l/14 cm p/18 cm v	čierny	4224 ks/pal
<b>46866</b>	na ruže RP	3 l/16 cm p/20,5 cm v	čierny	3724 ks/pal
<b>46868</b>	na ruže RP	4 l/18,5 cm p/21,5 cm v	čierny	3096 ks/pal
<b>46870</b>	na ruže RP	7 l/22 cm p/25,6 cm v	čierny	1650 ks/pal



Kód	názov	rozmer	farba	balenie
<b>45892</b>	Transportné plato FV122	24x kvetináč 9 x 9 cm	čierny	572 ks/pal
<b>46700</b>	VKR	15,8 x 15,8 x 16 cm 3 l	čierny	2520 ks/pal
<b>46715</b>	vysoký	9 x 9 x 14 cm 800 cc	čierny	7488 ks/pal
<b>46774</b>	Hranatý kvetináč	9 x 9 x 10 cm EX 500 cc	čierny	1260k/18876p
<b>46780</b>	Hranatý kvetináč	11 x 11 x 12 cm EX 1,0 l	čierny	660k/10000p
<b>46790</b>	Hranatý kvetináč	15 x 15 x 15 cm EX 2,3 l	čierny	4410 ks/pal
<b>46796</b>	Hranatý kvetináč	20 x 20 x 23 cm H 5,7 l	čierny	2040 ks/pal



Kód	názov	rozmer	farba	balenie
<b>46935</b>	na rezané kvety	3,0 l 18,5/17 cm v	čierny	7500 ks/pal H
<b>46937</b>	na rezané kvety	4,5 l 21,5/19,6 cm v	čierny	4500 ks/pal H
<b>46939</b>	na rezané kvety	5 l 23/20 cm v	čierny	4800 ks/pal H
<b>46941</b>	na rezané kvety	8 l 26,5/21 cm v	čierny	4140 ks/pal H
<b>46943</b>	na rezané kvety	10 l 26/25 cm v	čierny	3600 ks/pal H
<b>46945</b>	na rezané kvety	13 l 29/35 cm v	čierny	1500 ks/pal H

## Multiplata MODIFORM

### Multiplato 73



Kód	rozmer
<b>31815</b>	50 mm/62 cc - 52,5 x 30,5 cm

### Multiplato 150

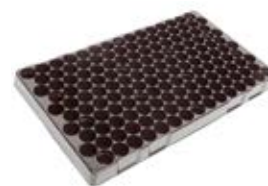

Kód	rozmer
<b>31825</b>	v 43 mm/25 cc - 52,5 x 30,5 cm

### Multiplato 60



Kód	rozmer
<b>31830</b>	v 45 mm/80 cc - 52,5 x 30,5 cm

### Multiplato 48



Kód	rozmer
<b>31856</b>	v 50 mm/96 cc - 52,5 x 30,5 cm

## Multiplatá MODIFORM

### Multiplato 240

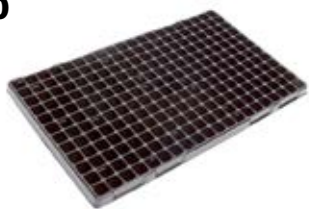

Kód

rozmer

**31920** v 30 mm/7,5 cc - 49 x 29 cm

### Multiplato 126

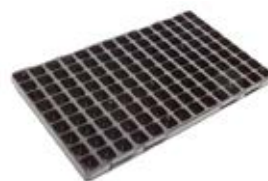

Kód

rozmer

**31950** v 32 mm/25 cc - 53 x 30 cm

### Multiplato 140



Kód

rozmer

**31961** v 50 mm/35 cc - 56 x 35 cm

### Clajette 2x 10



Kód

rozmer

**33545** 156 cc 2-pack 31 x 27 cm

### Endpack 6

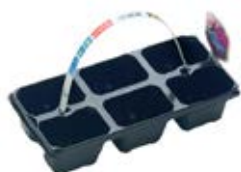

Kód

rozmer

**33550** 192 cc pack 28 x 12 cm

### Endpack 8



Kód

rozmer

**33555** 142 cc pack 28 x 12 cm

### Endpack 10



Kód

rozmer

**335600** 106 cc pack 28 x 12 cm

### Rúčka



Kód

rozmer

**33575** 40 cm

### Výsevné plato



Kód

rozmer

**33590** 58 x 38 cm, výška 3,5 cm

### Dänish



LEN NA  
OBJEDNÁVKU

Kód

rozmer

**33990** 10x 13 cm - 56 x 31,5 cm

## Multiplatá MODIFORM

## Normpack 406



## Normpack 408



Kód

rozmer

**33799**

6x 13/12 cm - 56 x 25 cm

Kód

rozmer

**33801**

8x 13/12 cm - 56 x 25 cm

## Normpack 408



Kód

rozmer

**33802**

8x 13/12 cm - 56 x 25 cm s dierami

## Normpack 409



Kód

rozmer

**33803**

9x 12 cm - 56 x 25 cm s dierami

## Normpack 418



Kód

rozmer

**33805**

18x 9 cm - 56 x 25 cm

## Normpack 418



Kód

rozmer

**33806**

18x 9 cm - 56 x 25 cm s dierami

## Normpack 488



Kód

rozmer

**33915**

8x 12 cm - 56 x 25 cm

## Normpack 478



Kód

rozmer

**33918**

8x 13 cm - 56 x 25 cm s dierami

## Normpack 488



Kód

rozmer

**33920**

8x 12 cm - 56 x 25 cm s dierami

## Normpack 488



Kód

rozmer

**33921**

8x 12 cm - 56 x 25 cm s dierami

LEN NA  
OBJEDNÁVKU

Multiplatá MODIFORM

Normpack 490



Kód	rozmer
<b>33922</b>	10x 11,5 - 56 x 25 cm s dierami

Universal



Kód	rozmer
<b>33925</b>	6/8/12x 9/13 cm - 40 x 28 cm

Normpack 245



Kód	rozmer
<b>33930</b>	20x 7 cm hranaté - 40 x 28 cm

Eurodan



Kód	rozmer
<b>33980</b>	6x 16 cm - 56 x 31,5 cm

Eurodan



Kód	rozmer
<b>339811</b>	6x 15 cm - 56 x 31,5 cm s dierami

Eurodan



Kód	rozmer
<b>339812</b>	8x 15 cm - 8° 56 x 31,5 cm s dierami

Eurodan



Kód	rozmer
<b>339813</b>	5x 17 cm - 56 x 31,5 cm s dierami

Eurodan



Kód	rozmer
<b>33982</b>	12x 12 cm - 56 x 31,5 cm

Eurodan



Kód	rozmer
<b>33983</b>	12x 12 cm - 56 x 31,5 cm s dierami

Eurodan



Kód	rozmer
<b>33984</b>	18x 9 cm hranaté - 56 x 31,5 cm s dierami



LEN NA  
OBJEDNÁVKU



Kód	názov	rozmer	farba
<b>11241P</b>	TERRA kvetináč	11/8,5 cm 0,5 l	terakota
<b>11242P</b>	TERRA kvetináč	13/10 cm 0,7 l	terakota
<b>11243P</b>	TERRA kvetináč	15/11,5 cm 1 l	terakota
<b>11244P</b>	TERRA kvetináč	17,5/13,5 cm 2 l	terakota
<b>11245P</b>	TERRA kvetináč	20/15,5 cm 3 l	terakota
<b>11246P</b>	TERRA kvetináč	25/19,5 cm 5 l	terakota
<b>11247P</b>	TERRA kvetináč	30/23,5 cm 8 l	terakota
<b>11248P</b>	TERRA kvetináč	35/27,5 cm 13 l	terakota
<b>11249P</b>	TERRA kvetináč	40/31,5 cm 20 l	terakota
<b>11250P</b>	TERRA kvetináč	45/35 cm 27 l	terakota
<b>11251P</b>	TERRA kvetináč	50/39 cm 38 l	terakota
<b>11252P</b>	TERRA kvetináč	55/43 cm 48 l	terakota
<b>11253P</b>	TERRA kvetináč	64/50 cm 78 l	terakota
<b>14241P</b>	TERRA podmiska	9/1,2 cm	terakota
<b>14242P</b>	TERRA podmiska	11/1,4 cm	terakota
<b>14243P</b>	TERRA podmiska	12/1,6 cm	terakota
<b>14244P</b>	TERRA podmiska	14/1,9 cm	terakota
<b>14245P</b>	TERRA podmiska	17/2,2 cm	terakota
<b>14246P</b>	TERRA podmiska	21/2,7 cm	terakota
<b>14247P</b>	TERRA podmiska	25/3,3 cm	terakota
<b>14248P</b>	TERRA podmiska	29/3,8 cm	terakota
<b>14249P</b>	TERRA podmiska	33/4,4 cm	terakota
<b>14250P</b>	TERRA podmiska	37/4,9 cm	terakota
<b>14251P</b>	TERRA podmiska	41/5,5 cm	terakota
<b>14252P</b>	TERRA podmiska	46/6 cm	terakota
<b>14253P</b>	TERRA podmiska	54/6,9 cm	terakota
<b>15121P</b>	TERRA misa	20/9,5 cm	terakota
<b>15122P</b>	TERRA misa	25/11,5 cm	terakota
<b>15123P</b>	TERRA misa	30/13 cm 6 l	terakota
<b>15124P</b>	TERRA misa	35/15 cm	terakota
<b>15125P</b>	TERRA misa	40/17 cm 14,5 l	terakota



Kód	názov	rozmer	farba
<b>11081P</b>	TERRA hran. kv.	15/13 cm 1,7 l	terakota
<b>11082P</b>	TERRA hran. kv.	19/16 cm 3,5 l	terakota
<b>11083P</b>	TERRA hran. kv.	24/20 cm 7 l	terakota
<b>11084P</b>	TERRA hran. kv.	30/25 cm 13,8 l	terakota
<b>11085P</b>	TERRA hran. kv.	37/30 cm 25,2 l	terakota
<b>11086P</b>	TERRA hran. kv.	45/35 cm 42 l	terakota
<b>14081P</b>	TERRA hr. podm.	14/1,9 cm	terakota
<b>14082P</b>	TERRA hr. podm.	17/2,4 cm	terakota
<b>14083P</b>	TERRA hr. podm.	22/3 cm	terakota
<b>14084P</b>	TERRA hr. podm.	27/3,8 cm	terakota
<b>14085P</b>	TERRA hr. podm.	34/4,5 cm	terakota
<b>14086P</b>	TERRA hr. podm.	41/5,5 cm	terakota
<b>14024P</b>	CROWN kv.	48/26,4 cm 16 l	terakota

Kód	názov	rozmer	farba
<b>41120</b>	CIOTOLA CAMPANA kv.	45 cm	terakota
<b>41140</b>	CIOTOLA CAMPANA kv.	50 cm	terakota
<b>41160</b>	CIOTOLA CAMPANA kv.	60 cm	terakota
<b>41130</b>	CAMPANA pod.	37/45 cm	terakota
<b>41150</b>	CAMPANA pod.	40/50 cm	terakota
<b>41170</b>	CAMPANA pod.	45/60 cm	terakota

## Vyvýšené záhony



Kód	popis	m. j.
<b>998000</b>	Diel dĺžka 40 cm x výška 50 cm s nopovou fóliou	ks
<b>998003</b>	Diel dĺžka 50 cm x výška 50 cm s nopovou fóliou	ks
<b>998004</b>	Diel dĺžka 50 cm x výška 61 cm s nopovou fóliou	ks
<b>998005</b>	Diel dĺžka 50 cm x výška 72 cm s nopovou fóliou	ks
<b>998009</b>	Diel dĺžka 80 cm x výška 50 cm s nopovou fóliou	ks
<b>998012</b>	Diel dĺžka 100 cm x výška 50 cm s nopovou fóliou	ks
<b>998013</b>	Diel dĺžka 100 cm x výška 61 cm s nopovou fóliou	ks
<b>998014</b>	Diel dĺžka 100 cm x výška 72 cm s nopovou fóliou	ks
<b>998015</b>	Diel dĺžka 150 cm x výška 50 cm s nopovou fóliou	ks
<b>998018</b>	Diel dĺžka 200 cm x výška 50 cm s nopovou fóliou	ks
<b>998099</b>	Vyvýšený záhon - montážna sada	ks



Kód	názov	rozmer	farba
<b>41700</b>	Garden hrantík	40 x 17 x 15 h cm 5,1 l	terakota
<b>41701</b>	Garden hrantík	40 x 17 x 15 h cm 5,1 l	hnedý
<b>41703</b>	Garden hrantík	40 x 17 x 15 h cm 5,1 l	mramor
<b>41704</b>	Garden hrantík	40 x 17 x 15 h cm 5,1 l	antracit
<b>41710</b>	Garden miska	40 x 17 x 3 cm	terakota
<b>41711</b>	Garden miska	40 x 17 x 3 cm	hnedá
<b>41713</b>	Garden miska	40 x 17 x 3 cm	mramor
<b>41714</b>	Garden miska	40 x 17 x 3 cm	antracit
<b>41720</b>	Garden hrantík	50 x 17 x 15 h cm 6,7 l	terakota
<b>41721</b>	Garden hrantík	50 x 17 x 15 h cm 6,7 l	hnedý
<b>41723</b>	Garden hrantík	50 x 17 x 15 h cm 6,7 l	mramor
<b>41724</b>	Garden hrantík	50 x 17 x 15 h cm 6,7 l	antracit
<b>41730</b>	Garden miska	50 x 17 x 3 cm	terakota
<b>41731</b>	Garden miska	50 x 17 x 3 cm	hnedá
<b>41733</b>	Garden miska	50 x 17 x 3 cm	mramor
<b>41734</b>	Garden miska	50 x 17 x 3 cm	antracit
<b>41740</b>	Garden hrantík	60 x 17 x 15 h cm 8,2 l	terakota
<b>41741</b>	Garden hrantík	60 x 17 x 15 h cm 8,2 l	hnedý
<b>41743</b>	Garden hrantík	60 x 17 x 15 h cm 8,2 l	mramor
<b>41744</b>	Garden hrantík	60 x 17 x 15 h cm 8,2 l	antracit
<b>41750</b>	Garden miska	60 x 17 x 3 cm	terakota
<b>41751</b>	Garden miska	60 x 17 x 3 cm	hnedá
<b>41753</b>	Garden miska	60 x 17 x 3 cm	mramor
<b>41754</b>	Garden miska	60 x 17 x 3 cm	antracit
<b>41760</b>	Garden hrantík	80 x 17 x 15 h cm 11,2 l	terakota
<b>41761</b>	Garden hrantík	80 x 17 x 15 h cm 11,2 l	hnedý
<b>41763</b>	Garden hrantík	80 x 17 x 15 h cm 11,2 l	mramor
<b>41764</b>	Garden hrantík	80 x 17 x 15 h cm 11,2 l	antracit
<b>41770</b>	Garden miska	80 x 17 x 3 cm	terakota
<b>41771</b>	Garden miska	80 x 17 x 3 cm	hnedá
<b>41773</b>	Garden miska	80 x 17 x 3 cm	mramor
<b>41774</b>	Garden miska	80 x 17 x 3 cm	antracit
<b>41780</b>	Garden hrantík	100 x 17 x 15 h cm 14 l	terakota
<b>41781</b>	Garden hrantík	100 x 17 x 15 h cm 14 l	hnedý
<b>41783</b>	Garden hrantík	100 x 17 x 15 h cm 14 l	mramor
<b>41784</b>	Garden hrantík	100 x 17 x 15 h cm 14 l	antracit
<b>41790</b>	Garden miska	100 x 17 x 3 cm	terakota
<b>41791</b>	Garden miska	100 x 17 x 3 cm	hnedá
<b>41793</b>	Garden miska	100 x 17 x 3 cm	mramor
<b>41794</b>	Garden miska	100 x 17 x 3 cm	antracit



## Hrantíky a príslušenstvo



Kód	názov	rozmer	farba
<b>41990</b>	Držiak	na hranu 12 cm	terakota
<b>41991</b>	Držiak	na rúrku 12 cm	terakota
<b>41992</b>	Držiak	na hranu 12 cm	hnedý
<b>41993</b>	Držiak	na rúrku 12 cm	hnedý
<b>41995</b>	Držiak	na hranu 15 cm	terakota
<b>41996</b>	Držiak	na rúrku 15 cm	terakota
<b>41997</b>	Držiak	na hranu 15 cm	hnedý
<b>41998</b>	Držiak	na rúrku 15 cm	hnedý



Kód	názov	rozmer	farba
<b>419990</b>	Kovový držiak	2 ks/bal.	Antracit
<b>419991</b>	Kovový držiak	2 ks/bal.	Terracota



Kód	názov	rozmer	farba
<b>15015P</b>	kôš na cibuľoviny Onion II.	21,5/5,4 cm	lesná zeleň
<b>15016P</b>	kôš na cibuľoviny Onion II.	26,5/5,6 cm	lesná zeleň
<b>15017P</b>	kôš na cibuľoviny Onion II.	31,5/5,6 cm	lesná zeleň

## Príslušenstvo



Kód	názov	rozmer	farba	balenie
<b>78401000</b>	Záhonový štítok	34/9 x 6 cm x 34 cm	slonovinová	100 ks
<b>78305007</b>	Záhonový štítok	13,5/5 x 3 cm x 13,5 cm	slonovinová	250 ks



Kód	názov	rozmer	farba	balenie
<b>78105007</b>	Záhonový štítok	EP10 10,0 x 1,5 cm	slonovinová	1000 ks
<b>78205007</b>	Záhonový štítok	EP14 14,0 x 1,8 cm	slonovinová	250 ks



Kód	názov	rozmer	farba	balenie
<b>35510</b>	Rýchloviazač	115 mm	čierna	1000 ks
<b>35520</b>	Rýchloviazač	145 mm	čierna	1000 ks



LEN NA  
OBJEDNÁVKU



Kód	názov	objem	farba	balenie
<b>42000</b>	Spring	1,7 l	rôzna	8x 58/pal.
<b>42010</b>	Spring	2,5 l	rôzna	6x 40/pal.
<b>42020</b>	Spring	4,5 l	rôzna	6x 32/pal.
<b>42030</b>	Spring	8 l	rôzna	5x 20/pal.
<b>42040</b>	Spring	10,5 l	rôzna	4x 16/pal.
<b>42050</b>	Spring	13,5 l	rôzna	4x 14/pal.



Kód	názov	objem	farba	balenie
<b>42080</b>	Krhla s ružicou	5 l	zelená	20x 140/pal.
<b>42090</b>	Krhla s ružicou	10 l	zelená	10x 140/pal.

Selektívne herbicídy

**Bofix**



Kód	balenie	m. j.
<b>80662</b>	250 ml	ks
<b>80663</b>	100 ml	ks
<b>80661</b>	1 l	ks

**Agil 100EC**



Kód	balenie	m. j.
<b>80071</b>	100 ml	ks

**Stomp Aqua**



Kód	balenie	m. j.
<b>842320</b>	250 ml	ks

**Dicopur M750**



Kód	balenie	m. j.
<b>81370</b>	500 ml	ks

Totálne herbicídy

**Roundup biaktiv M**



Kód	balenie	m. j.
<b>83902</b>	1 l	l
<b>83922</b>	20 l	l

**Touchdown System 4**



Kód	balenie	m. j.
<b>84710</b>	50 ml	ks

**Kaput Green**



Kód	balenie	m. j.
<b>82468</b>	250 ml	ks
<b>82466</b>	500 ml	ks
<b>82464</b>	1 l	ks

**Clinic UP**



Kód	balenie	m. j.
<b>80950</b>	5 l	l
<b>80945</b>	20 l	l

**Champion 50 WG**

Kód	balenie
<b>823350</b>	10 x 20 g

**Askon**

Kód	balenie
<b>80370</b>	10 ml

**Energy Magnicur**

Kód	balenie
<b>81560</b>	15 ml

**Fungimat Magnicur**

Kód	balenie
<b>81711</b>	50 ml

**Thiovit**

Kód	balenie
<b>84631</b>	5 x 60 g

**Prolectus**

Kód	balenie
<b>83500</b>	5 x 12 g

**Signum**

Kód	balenie
<b>84050</b>	15 g

**Dynali**

Kód	balenie
<b>81541</b>	6,5 ml
<b>81540</b>	250 ml

**Rock Effect**

Kód	balenie
<b>83782</b>	100 ml

Fungicídy

Cantus



Kód	balenie	m. j.
<b>80810</b>	5x 12 g	ks

Qualy 300EC



Kód	balenie	m. j.
<b>83530</b>	5 ml	ks

Cuproxat SC



Kód	balenie	m. j.
<b>81111</b>	100 ml	ks

Insekticídy

Apollo 50 SC



Kód	balenie	m. j.
<b>80332</b>	8 ml	ks

Sanium Ultra



Kód	balenie	m. j.
<b>84170</b>	2x 5 ml	ks
<b>84172</b>	30 ml	ks

Karate Zeon



Kód	balenie	m. j.
<b>82482</b>	5 ml	ks
<b>82483</b>	50 ml	ks

Metarex



Kód	balenie	m. j.
<b>82994</b>	100 g	ks
<b>82993</b>	3x 100 g	ks

Mospilan 20 SP M



Kód	balenie	m. j.
<b>83127</b>	0,6 g	ks
<b>83126</b>	3x 0,6 g	ks
<b>83125</b>	1,5 g	ks
<b>83123</b>	15 g	ks

Ortus 5 SC



Kód	balenie	m. j.
<b>83301</b>	10 ml	ks

Spintor



Kód	balenie	m. j.
<b>84192</b>	6 ml	ks
<b>84191</b>	25 ml	ks

GRANULAX - proti slimákom



Kód	balenie	m. j.
<b>81381</b>	250 g	ks

### Champion Almus



Kód	balenie	m. j.
<b>82337</b>	250 ml	ks
<b>823370</b>	500 ml	ks
<b>823371</b>	200 ml	ks

### Gondola



Kód	balenie	m. j.
<b>81374</b>	2 ml	ks

### Mavrik 2F



Kód	balenie	m. j.
<b>82940</b>	5 ml	ks

### Nissorun 10 WP



Kód	balenie	m. j.
<b>83193</b>	5x 10 g	ks

### Talpa Raus



Kód	balenie	m. j.
<b>84408</b>	1 kg	ks

## Predjarný postrek

### Mero stefes + karate zeon

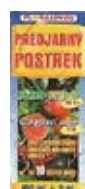

Kód	balenie	m. j.
<b>83470</b>	100 ml + 5 ml	ks
<b>83472</b>	250 ml + 12,5 ml	ks

## Ochrana proti hmyzu

### Nástraha na mravce (granulát)



Kód	balenie	m. j.
<b>83132</b>	100 g	ks

### Sojet - proti muchám (vodorozpustný granulát)



Kód	balenie	m. j.
<b>84130</b>	100 g	ks

### Agita - proti muchám



Kód	balenie	m. j.
<b>80080</b>	100 g	ks
<b>80079</b>	400 g	ks

### Biotoll prášok proti mravcom



Kód	balenie	m. j.
<b>50173</b>	100 g	ks

**NeemAzal T/S**



Kód	balenie	m. j.
<b>831190</b>	100 ml	ks

**ROOT** - likvidátor koreňového systému



Kód	balenie	m. j.
<b>84263</b>	100 ml	ks

**Lepidlo na ochranu stromov**



Kód	balenie	m. j.
<b>84262</b>	250 ml	ks

**FLORA VITA Citro - biologické proti chorobám**



Kód	balenie	m. j.
<b>82241</b>	100 ml	ks

**FLORA VITA Coco - biologické proti chorobám**



Kód	balenie	m. j.
<b>82242</b>	100 ml	ks

**Polyversum 5 g - biologické proti chorobám**



Kód	balenie	m. j.
<b>82244</b>	100 ml	ks

**Trifender - biologické hnojivo s fungicídny m účinkom**



Kód	balenie	m. j.
<b>82243</b>	3x 10 g	ks

**Novaferm Orion**



Kód	balenie	m. j.
<b>81186</b>	250 ml	ks

**Novaferm Viva**



Kód	balenie	m. j.
<b>81187</b>	250 ml	ks

**Chemstop Ecofix**



Kód	balenie	m. j.
<b>849983</b>	250 ml	ks

### Komposto

KOMPOSTO od Zeleko je prírodný prípravok, ktorý urýchľuje a zlepšuje tvorbu kompostu. Rozkladá organický odpad a obohacuje kompost o prospešné mikroorganizmy.



NEW

Kód	balenie	m. j.
<b>831200</b>	300 g	ks

### Reteneko

RETENeko od Zeleko je zmes prírodných baktérií určená na čistenie retenčných nádrží. Eliminuje zápach, zlepšuje priehľadnosť vody a rozkladá nečistoty.



NEW

Kód	balenie	m. j.
<b>831201</b>	1000 g	ks

### Fertiko s mykorhízou

FERTIKO je unikátny prírodný produkt na báze pôdných mikroorganizmov a mykorhíznych húb, ktoré sprístupňujú živiny rastlinám. Podporuje zdravý rast, zlepšuje imunitu a odolnosť voči stresu.



NEW

Kód	balenie	m. j.
<b>831203</b>	100 g	ks
<b>831204</b>	300 g	ks

### BMV

BMV je zmes prirodzene sa vyskytujúcich mikroorganizmov, ktoré parazitujú na škodcoch. Nezaťažuje vodu a prírodu, je bezpečná pre včely, zvieratá a vtáky.



NEW

Kód	balenie	m. j.
<b>831205</b>	100 g	ks

### Mosqiteko

MOSQITEKO je prírodný bakteriálny prípravok obsahujúci Bacillus thuringiensis var. israelensis, ktorý efektívne likviduje larvy komárov a muchničiek. Je bezpečný pre ľudí, zvieratá, vtáky a včely.



NEW

Kód	balenie	m. j.
<b>831206</b>	250 ml	ks

## Prídavné látky a hnojivá

**Rhodovit** - pomocný prípravok pre pestovanie kyslomilných rastlín



Kód	balenie	m. j.
<b>70330</b>	100 g	ks

**Symbivit**



Kód	balenie	m. j.
<b>70315</b>	150 g	ks
<b>70320</b>	750 g	ks
<b>70321</b>	3 kg	ks
<b>70325</b>	20 kg	ks

**Plantasorb** - prípravok zadržiavajúci pôdnu vlhkosť



Kód	balenie	m. j.
<b>70360</b>	750 g	ks

**Oasis EM-1** - pôdne mikrobiologické hnojivo



Kód	balenie	m. j.
<b>81190</b>	100 ml	ks
<b>811900</b>	250 ml	ks

**Symbivit paradajky a papriky**



Kód	balenie	m. j.
<b>70338</b>	150 g	ks
<b>70340</b>	750 g	ks

**Ectovit** - pomocný prípravok pre pestovanie rastlín



Kód	balenie	m. j.
<b>70350</b>	300 g	ks

## Bio Plantella

**Lepové dosky žlté**

(entomolog. lepidlo, bez ochr. lehoty)



Kód	balenie	m. j.
<b>849980</b>	5 ks	ks

**Lepové dosky biele**

(entomolog. lepidlo, bez ochr. lehoty)



Kód	balenie	m. j.
<b>849972</b>	10 ks	ks

**Obojstranne lepiaci pás na stromy - vošky, piadivky, mravce**



Kód	balenie	m. j.
<b>849970</b>	5 m	ks

**PROTEKT ochr. náter na stromy so železom a haseným vápnom**



Kód	balenie	m. j.
<b>849974</b>	1,5 kg	ks

## Stimulátor zakoreňovania AS-1



Kód	balenie	m. j.
<b>80009</b>	75 g	ks

## Stimulátor zakoreňovania Vetozen



Kód	balenie	m. j.
<b>80012</b>	300 g	ks

**RootMost prírodný koreňový stimulátor**  
 na 1000 m<sup>2</sup>, na báze morských rias

Kód	balenie	m. j.
<b>81185</b>	100 ml	ks

## Ochrana proti škodcom

## Chránič na kmene Treex Flexguard



Kód	rozmery	balenie	m. j.
<b>122005</b>	11 x 80 cm	6 ks	ks
<b>122006</b>	11 x 110 cm	6 ks	ks

## Dymovnica proti podzemným škodcom



Kód	balenie	m. j.
<b>79900</b>	5 ks	bal.

## Stop škodcom Gel profesionál na hlodavce



Kód	balenie	m. j.
<b>799600</b>	300 g	ks

## PROTECT NATURAL - odpudzovač krtov



Kód	balenie	m. j.
<b>799001</b>	50 ks	ks

**Swissinno Supercat guillotine - pasca**  
 na hlodavce

Kód	m. j.
<b>1551000</b>	ks

**Ratimor brodifacoum**  
 mäkká nástraha

Kód	balenie	m. j.
<b>52601</b>	150 g	ks

**Ratimor brodifacoum**  
 parafinové bloky

Kód	balenie	m. j.
<b>52608</b>	300 g	ks

**Ratimor plus bromadiolon**  
 zrno, obilná nástraha

Kód	balenie	m. j.
<b>52831</b>	150 g	ks

**Ratimor plus lepené dosky**  
 na myši, extra silná!

Kód	balenie	m. j.
<b>40600</b>	2 ks	ks

Chémia - ostatný tovar

**Machožrút** (proti machu na zámkovú dlažbu)



Kód	balenie	m. j.
<b>82850</b>	1 l	l

**Silwet Star zmáčadlo**



Kód	balenie	m. j.
<b>84103</b>	1 l	l
<b>841040</b>	15 ml	ks
<b>84105</b>	50 ml	ks

**Štepársky vosk Dendrosan**



Kód	balenie	m. j.
<b>84261</b>	150 g	ks

**Stromový balzam Dendrosan**



Kód	balenie	m. j.
<b>84260</b>	150 g	ks

Postrekovače

**Rozprašovač ručný VENEZIA**



Kód	balenie	m. j.
<b>12045</b>	600 ml	ks
<b>12040</b>	1000 ml	ks

**Postrekovač ručný GAMMA**



Kód	balenie	m. j.
<b>12005</b>	5 l	ks
<b>12007</b>	7 l	ks
<b>12010</b>	10 l	ks

**Postrekovač ručný Thema**



Kód	balenie	m. j.
<b>12002</b>	2 l	ks

**Postrekovač ručný Skveler**



Kód	balenie	m. j.
<b>15901000</b>	1 l	ks
<b>15901001</b>	2 l	ks

**Postrekovač chrbtový MIURA s teleskopom**



Kód	balenie	m. j.
<b>12012</b>	12 l	ks
<b>12016</b>	16 l	ks
<b>12022</b>	22 l	ks

**Postrekovač chrbtový ELECTRA 16l**

Li-Ion s teleskopom, elektrický



Kód	balenie	m. j.
<b>12018</b>	16 l	ks

## Vonkajšia ochrana proti komárom

### Rozlúčte sa so sprejmi

S technológiou Thermacell Mosquito Repellent Technology Zone sa zbavíte obťažujúceho hmyzu. Mnohé štúdie potvrdzujú až 98% efektívnosť výrobkov Thermacell pri ochrane pred komármi a iným otravným krv sajúcim hmyzom s ochrannou zónou až 20 m<sup>2</sup>.



**THERMACELL**



### Ručný odpudzovač MR-300



Kód	parametre	balenie
<b>MR-300L</b>	čierny	6 ks/bal.

### Kempingový odpudzovač



Kód	parametre	balenie
<b>MR-BP</b>		6 ks/bal.

### Halo Mini odpudzovač komárov



Kód	parametre	balenie
<b>MR-PSL</b>	graphit	6 ks/bal.

### Náhradné butánové kartuše



Kód	parametre	balenie
<b>C-4</b>		12 ks/bal.

### Náhradné vankúšiky do kempingového odpudzovača



Kód	parametre	balenie
<b>M-48</b>		12 ks/bal.

### Náhradné náplne na 48 hod



Kód	parametre	balenie
<b>R-4</b>	12x poduška, 4x bombička	12 ks/bal.

## Ochrana proti hmyzu



Kód	názov	m. j.
<b>1234020</b>	Pasca na hmyz GF-20BL	ks



Kód	názov	m. j.
<b>1234021</b>	Pasca na hmyz GF-7CN	ks



Kód	názov	m. j.
<b>1234022</b>	Lapač hmyzu GH-10C	ks



Kód	názov	m. j.
<b>1234023</b>	Lapač hmyzu GH-18A	ks



Kód	názov	m. j.
<b>1234024</b>	Lapač hmyzu GA-30E	ks



Kód	názov	m. j.
<b>1234025</b>	Lapač hmyzu GC2-30	ks



Aromatické sviečky proti komárom

Sviečka Citronella v skle



Kód	doba horenia	m. j.
<b>720200</b>	40 hod	ks

Sviečka Citronella v obalenom skle



Kód	doba horenia	m. j.
<b>720201</b>	29 hod	ks

Čajové sviečky Citronella - balenie 18 ks



Kód	doba horenia	m. j.
<b>720202</b>	4 hod	bal

Elektronické odpudzovače Weitech

Špirála proti komárom Citronella



**NEW**

Kód	m. j.
<b>WK8021</b>	ks

Elektrická raketa proti komárom



**NEW**



Kód	m. j.
<b>WK0071</b>	bal

UV lapač komárov s 2 ventilátormi, 50 m<sup>2</sup>, do interiéru, napájaný zo siete



**NEW**

Kód	m. j.
<b>WK0116</b>	ks

Záhradná fakľa Citronella proti komárom, 3 ks



**NEW**

Kód	m. j.
<b>WK8022</b>	bal

Elektronické odpudzovače Weitech

Ultrazvukový odpudzovač proti komárom, 50 m<sup>2</sup>, na batérie



NEW

Kód	m. j.
<b>WK0029</b>	ks

Ultrazvukový odpudzovač proti komárom, 50 m<sup>2</sup>, napájaný zo siete



NEW

Kód	m. j.
<b>WK0028</b>	bal

LED UV lapač hmyzu, 30 m<sup>2</sup>, do interiéru aj exteriéru, napájaný zo siete



NEW

Kód	m. j.
<b>WK0115</b>	ks

Elektrická mucholapka na hmyz



NEW

Kód	m. j.
<b>WK8032</b>	ks

Žltá lepová doska, na zapichnutie, 2 ks



NEW

Kód	m. j.
<b>WK8004</b>	bal

Ultrazvukový odpudzovač proti muchám, 20 m<sup>2</sup>, do interiéru, napájaný zo siete



NEW

Kód	m. j.
<b>WK0206</b>	ks

Odpudzovač proti mravcom, s vibráciou



NEW

Kód	m. j.
<b>WK2017</b>	ks

Ultrazvukový odpudzovač proti osám



NEW

Kód	m. j.
<b>WK0023</b>	ks

Elektronické odpudzovače Weitech

Imitácia osieho hniezda



NEW

Kód	m. j.
WK0432	ks

Ultrazvukový odpudzovač proti škodcom, 325 m<sup>2</sup>, napájaný zo siete



NEW

Kód	m. j.
WK0600	ks

Ultrazvukový odpudzovač proti škodcom s vypínateľným nočným svetlom, 90 m<sup>2</sup>, napájaný zo siete



NEW

Kód	m. j.
WK0190	ks

Ultrazvukový odpudzovač proti škodcom, 140 m<sup>2</sup>, napájaný zo siete



NEW

Kód	m. j.
WK0220	ks

Ultrazvukový odpudzovač proti škodcom, 280 m<sup>2</sup>



NEW

Kód	m. j.
WK0300	bal

Ultrazvukový odpudzovač proti škodcom, 45 m<sup>2</sup>, napájaný zo siete



NEW

Kód	m. j.
WK0523	ks

Ultrazvukový odpudzovač proti škodcom, 45 m<sup>2</sup>, napájaný zo siete, 3 ks v balení



NEW

Kód	m. j.
WK3523	bal

Ultrazvukový odpudzovač proti škodcom, 60 m<sup>2</sup>, na batérie



NEW

Kód	m. j.
WK0240	ks

Elektronické odpudzovače Weitech

Ultrazvukový a elektromagnetický odpudzovač, 2 v 1



NEW

Kód	m. j.
WK1003	ks

Ultrazvukový odpudzovač proti potkanom a myšiam



NEW

Kód	m. j.
WK0400	ks

Ultrazvukový odpudzovač proti potkanom a myšiam, IP44



NEW

Kód	m. j.
WK0344	ks

Odpudzovač proti kunám a hlodavcom, do auta



NEW

Kód	m. j.
WK0508	ks

Ultrazvukový plašič proti malej zveri, napájaný z USB



NEW

Kód	m. j.
WK0100	ks

Mini odpudzovač proti krtom, max 400 m<sup>2</sup>, solárny, 2 ks v balení



NEW

Kód	m. j.
WK2015	bal

Odpudzovač proti krtom v tvare slnečnice, solárny, 2 ks v balení

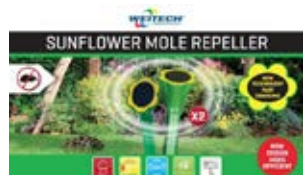

NEW

Kód	m. j.
WK2018	bal

Odpudzovač proti krtom, 350 m<sup>2</sup>, solárny



NEW

Kód	m. j.
WK0677	bal

Odpudzovač proti krtom, 100 m<sup>2</sup>, na batérie



NEW

Kód	m. j.
WK0675	ks

Ultrazvukový odpudzovač proti vtákom



NEW

Kód	m. j.
WK0108	ks

Elektronické odpudzovače Weitech

Ultrazvukový odpudzovač proti holubom



NEW

Kód	m. j.
WK0021	ks

Odpudzovač proti hadom, solárny



NEW

Kód	m. j.
WK2030	ks

Ultrazvukový plašič proti psom a mačkám, solárny



NEW

Kód	m. j.
WK0053	ks

Ultrazvukový plašič proti psom a mačkám, 200 m<sup>2</sup>, napájanie zo siete alebo na batérie



NEW

Kód	m. j.
WK0055	ks

Ultrazvukový plašič proti psom a mačkám, 200 m<sup>2</sup>, s bleskom



NEW

Kód	m. j.
WK0052	ks

Záhradný odpudzovač proti psom, mačkám, líškam, králikom, kunám, volavkám atď, s bleskom



NEW

Kód	m. j.
WK0054	ks

Ultrazvukový odpudzovač proti divej zveri, 50 m<sup>2</sup>, solárny



NEW

Kód	m. j.
WK0302	ks

Dekoračné zvieratá



Kód	názov	m. j.
<b>1065045</b>	Divý káčer	ks



Kód	názov	m. j.
<b>1065148</b>	Káčica Teal	ks



Kód	názov	m. j.
<b>1065454</b>	Káčer Teal	ks



Kód	názov	m. j.
<b>1065722</b>	Káčer Pintail	ks



Kód	názov	m. j.
<b>1382502</b>	Labuť	ks



Kód	názov	m. j.
<b>1382503</b>	Plameniak	ks

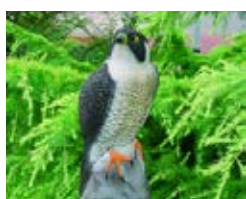

Kód	názov	m. j.
<b>1382522</b>	Sokol	ks



Kód	názov	m. j.
<b>1382532</b>	Sova malá/3 ks bal.	ks



Kód	názov	m. j.
<b>1382540</b>	Káčer biely/4 ks bal.	ks



Kód	názov	m. j.
<b>850500</b>	Bocian 66 x 25 x 78 cm	ks



Kód	názov	m. j.
<b>850501</b>	Sova s pohyblivou hlavou	ks



Kód	názov	m. j.
<b>850505</b>	Sova 14 x 11 x 32 cm	ks



Kód	názov	m. j.
<b>850506</b>	Sova 42 x 18 x 19 cm	ks



Kód	názov	m. j.
<b>850519</b>	Vrana 36 x 9 x 13 cm	ks



Kód	názov	m. j.
<b>850540</b>	Káčer 36 x 15 x 15 cm	ks



Kód	názov	m. j.
<b>850541</b>	Kačica 47 x 17 x 19 cm	ks



Kód	názov	m. j.
<b>850542</b>	Sova 33 x 28 x 50 cm	ks



Kód	názov	m. j.
<b>850543</b>	Sova so zvukom 20 x 18 x 43 cm	ks



Kód	názov	m. j.
<b>850544</b>	Sova so svietiacimi očami 19 x 18 x 43 cm	ks



Kód	názov	m. j.
<b>850545</b>	Sova s pohyblivou hlavou 20 x 19 x 39 cm	ks

Dekoračné zvieratá



Kód	názov	m. j.
<b>850546</b>	Vrana so zvukom, solar 13 x 11 x 38 cm	ks



Kód	názov	m. j.
<b>850547</b>	Vrana s rozťahnutými krídlami 80 x 11 x 45 cm	ks



Kód	názov	m. j.
<b>850548</b>	Bocian 66 x 25 x 78 cm	ks



Kód	názov	m. j.
<b>850557</b>	Volavka 72 x 18 x 71 cm	ks



Kód	názov	m. j.
<b>850558</b>	Vrana 43 x 14 x 20 cm	ks



Kód	názov	m. j.
<b>850991</b>	Sova 11 x 9 x 24 cm	ks



Kód	názov	m. j.
<b>850549</b>	Reflexná špirála na plašenie vtákov, rôzne farby, 45 cm	ks



Kód	názov	m. j.
<b>850550</b>	Špirála na plašenie vtákov	ks



Kód	názov	m. j.
<b>850551</b>	Reflexný plašič vtákov	ks



Kód	názov	m. j.
<b>850552</b>	Reflexné disky s okom na plašenie vtákov	ks



Kód	názov	m. j.
<b>850553</b>	Nafukovací balón so špirálou na plašenie vtákov 28 x 130 cm	ks



Kód	názov	m. j.
<b>850554</b>	Nafukovací balón na plašenie vtákov 40 cm	ks



Kód	názov	m. j.
<b>850555</b>	Balón na plašenie vtákov	ks



Kód	názov	m. j.
<b>850556</b>	Imitácia osieho hniezda	ks

**PONTAQUA**



Kód	názov
<b>5504</b>	Chlór Šok/Štart 1 kg
<b>5505</b>	Chlór Šok/Štart 3 kg



Kód	názov
<b>5502</b>	Chlórové tablety 200 g 1 kg



Kód	názov
<b>5507</b>	Multifunkčné tablety 20 g 1 kg
<b>5508</b>	Multifunkčné tablety 200 g 1 kg
<b>5509</b>	Multifunkčné tablety 200 g 3 kg



Kód	názov
<b>5511</b>	pH mínus 1,5 kg
<b>5512</b>	pH mínus 6 kg
<b>5513</b>	pH plus 0,8 kg



Kód	názov
<b>5515</b>	Stabilizátor tvrdosti 1 l
<b>5516</b>	Stabilizátor tvrdosti 5 l



Kód	názov
<b>5520</b>	Algicid Super 1 l
<b>5519</b>	Algicid Super 5 l
<b>5521</b>	Algicid 1 l s vôňou aloe vera
<b>5522</b>	Algicid 1 l s vôňou kamilky



Kód	názov
<b>5530</b>	Vločkovač tekutý 1 l
<b>5531</b>	Vločkovač kartuše 8 ks



Kód	názov
<b>5533</b>	Odpeňovač 0,5 l



Kód	názov
<b>5536</b>	Štartovacia sada pre bazény 5v1



Kód	názov
<b>5537</b>	EasySPA sada pre vírivky



Kód	názov
<b>5540</b>	Čistič odvápnovač 1 l



Kód	názov
<b>5542</b>	Čistič gelový alkalický 1 l



Kód	názov
<b>5544</b>	Odstraňovač kovov 1 l



Kód	názov
<b>5545</b>	Čistič filtrov 3x 100 g



Kód	názov
<b>5525</b>	Zazimovač 1 l



Kód	názov
<b>5113391</b>	WHIRLPOOL SET tablety (OXI)



Kód	názov
<b>5112547</b>	OXI tablety 20 g mini 1 kg



Kód	názov
<b>5112973</b>	OXI granulát 1 kg



Kód	názov
<b>6020</b>	Bazénový vysávač s bočnými kefami



Kód	názov
<b>6025</b>	Bazénová kefa rohová



Kód	názov
<b>229100</b>	Ručný vysávač TRI Deluxe OCEAN



Kód	názov
<b>6022</b>	Bazénová kefa zakrivená 46cm



Kód	názov
<b>6023</b>	Bazénová kefa s rukovetou biela



Kód	názov
<b>6024</b>	Bazénová špongia modrá



Kód	názov
<b>6026</b>	Hladinová sieťka modrá



Kód	názov
<b>6027</b>	Dnová sieťka modrá



Kód	názov
<b>6029</b>	Bazénový podberák teleskopický 3 x 40 cm



Kód	názov
<b>6035</b>	Vysávačová hadica modrá d 38/7,5 m VA
<b>6036</b>	Vysávačová hadica modrá d 38/9 m VA
<b>6037</b>	Vysávačová hadica modrá d 38/12 m VA



Kód	názov
<b>229009</b>	Tyč teleskop. 2-dielna Ocean AL 1,8 - 3,6 m
<b>229010</b>	Tyč teleskop. 2-dielna Ocean AL 2,4 - 4,8 m
<b>229011</b>	Tyč teleskop. 2-dielna Ocean AL 3,75 - 7,5 m



Kód	názov
<b>6030</b>	Teleskopická tyč 2 x 180 cm modrá



Kód	názov
<b>2200000</b>	Hadica vysávačová modrá 32/110 cm/bal. 50,6 m
<b>229012</b>	Hadica vysávačová modrá ECO k vysávačom d 38 mm



Kód	názov
<b>5112327</b>	Hadica plávajúca čierna 32 mm/55 cm, bal. 49,5 m
<b>5112328</b>	Hadica plávajúca čierna 38 mm/150 cm, bal. 51 m



Kód	názov
<b>229019</b>	Trň hadicový obojstranný 32 mm
<b>229020</b>	Trň hadicový obojstranný 38 mm
<b>400233</b>	Hadicová spojka d 38 - 32
<b>400234</b>	Adaptér lepiaci biely 38 x 50 ABS
<b>400235</b>	Adaptér lepiaci biely redukovaný d 32 - 38 x 50 ABS



Kód	názov
<b>145625</b>	Hadicová spona 25 - 40 mm NEREZ, 100 ks/bal.



Kód	názov
<b>6038</b>	Dávkovač tabliet Mini
<b>6039</b>	Dávkovač tabliet Maxi



Kód	názov
<b>229008</b>	Dávkovač chlóru plávajúci OCEAN



Kód	názov
<b>6040</b>	Dávkovač tabliet s teplomerom Mini



Kód	názov
<b>6041</b>	Dávkovač tabliet s teplomerom Maxi



Kód	názov
<b>6047</b>	Teplomer bazénový rybička



Kód	názov
<b>6049</b>	Teplomer bazénový delfín



Kód	názov
<b>6050</b>	Teplomer bazénový korytnačka



Kód	názov
<b>6048</b>	Teplomer bazénový kačička



Kód	názov
<b>229018</b>	Teplomer OCEAN guľatý



Kód	názov
<b>6043</b>	Teplomer bazénový biely



Kód	názov
<b>700152</b>	Špongia tvrdená OCEAN (balenie 2 ks)



Kód	názov
<b>5113677</b>	AQUAKRYSTAL - Absorbér masnoty a olejov do skimmra (balenie 2 ks) /24 ks box



Kód	názov
<b>400180</b>	Tester OCEAN tabletkový pH/Cl

Kód	názov
<b>400188</b>	Náhradné tablety do testera DPD1 (chlór)
<b>400189</b>	Náhradné tablety do testera pH



Kód	názov
<b>6042</b>	Tester kvapkový pH & Cl

Kód	názov
<b>5112410</b>	OXY tester



Kód	názov
<b>5112823</b>	Testovacie pásiky 4v1 AquaChek

Kód	názov
<b>5112824</b>	Testovacie pásiky 7v1 AquaChek



Kód	názov
<b>5112825</b>	Testovacie pásiky SALT TEST AquaChek

Kód	názov
<b>899800</b>	Morská soľ špeciál, praná/sušená 1 - 3 mm



Kód	názov	balenie
<b>8000054</b>	Filtročný piesok 0,2 - 0,8 mm	25 kg
<b>80000510</b>	Filtročný piesok 0,5 - 1 mm	25 kg
<b>8000049</b>	Filtročný piesok 0,8 - 1,2 mm	25 kg
<b>8000050</b>	Filtročný piesok AFM 2 - 3 mm	25 kg
<b>5112104</b>	Filtročný piesok AFM 3 - 5 mm	25 kg

Kód	názov	balenie
<b>898808</b>	Filtročné sklo 0,5 - 1 mm	25 kg
<b>5113521</b>	Filtročné sklo 0,5 - 1,25 mm	20 kg
<b>700011</b>	Filtročné sklo 1 - 3 mm	25 kg
<b>5112594</b>	Filtročné sklo AFM 0,4 - 1 mm	21 kg
<b>5112595</b>	Filtročné sklo AFM 1 - 2 mm	21 kg

## Netkané textílie mulčovacie

### Balená - čierna



Kód	gramáž	rozmary	m. j.	bal.
<b>21000</b>	50 g/m <sup>2</sup>	1,6 x 5 m	ks	20
<b>21100</b>	50 g/m <sup>2</sup>	1,6 x 10 m	ks	10
<b>21200</b>	50 g/m <sup>2</sup>	3,2 x 5 m	ks	10
<b>21300</b>	50 g/m <sup>2</sup>	3,2 x 10 m	ks	5

### Balená - biela



Kód	gramáž	rozmary	m. j.	bal.
<b>20000</b>	17 g/m <sup>2</sup>	1,6 x 5 m	ks	50
<b>20100</b>	17 g/m <sup>2</sup>	1,6 x 10 m	ks	25
<b>20200</b>	17 g/m <sup>2</sup>	3,2 x 5 m	ks	25
<b>20300</b>	17 g/m <sup>2</sup>	3,2 x 10 m	ks	12
<b>20400</b>	17 g/m <sup>2</sup>	4,2 x 10 m	ks	5
<b>20500</b>	17 g/m <sup>2</sup>	4,2 x 20 m	ks	5
<b>20600</b>	17 g/m <sup>2</sup>	6,35 x 10 m	ks	5
<b>20700</b>	17 g/m <sup>2</sup>	6,35 x 20 m	ks	3

### Kotúč - čierna



Kód	gramáž	rozmary	m. j.
<b>24080</b>	50 g/m <sup>2</sup>	0,8 x 100 m	ks
<b>24160</b>	50 g/m <sup>2</sup>	1,6 x 100 m	ks
<b>24320</b>	50 g/m <sup>2</sup>	3,2 x 100 m	ks

### Kotúč - hnedá



Kód	gramáž	rozmary	m. j.
<b>24060</b>	45 g/m <sup>2</sup>	1,6 x 100 m	ks

### Kotúč - biela



Kód	gramáž	rozmary	m. j.
<b>22160</b>	17 g/m <sup>2</sup>	1,6 x 100 m	ks
<b>22320</b>	17 g/m <sup>2</sup>	3,2 x 100 m	ks
<b>22330</b>	17 g/m <sup>2</sup>	6,35 x 100 m	ks
<b>22350</b>	17 g/m <sup>2</sup>	12,65 x 100 m	ks
<b>22635</b>	19 g/m <sup>2</sup>	6,35 x 100 m	ks
<b>22950</b>	19 g/m <sup>2</sup>	9,5 x 100 m	ks
<b>23050</b>	19 g/m <sup>2</sup>	10,5 x 100 m	ks
<b>23265</b>	19 g/m <sup>2</sup>	12,65 x 100 m	ks
<b>23580</b>	19 g/m <sup>2</sup>	15,8 x 100 m	ks

### Kotviaci hák

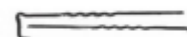

Kód	názov	m. j.	bal.
<b>3200</b>	kotviaci hák	ks	50
<b>3201</b>	kotviaci hák	ks	500

**Balená**

Kód	gramáž	rozmary	m. j.
<b>28980</b>	100 g/m <sup>2</sup>	1,6 x 5 m	ks
<b>28990</b>	100 g/m <sup>2</sup>	1,6 x 10 m	ks

**Kotúč 100 g/m<sup>2</sup>**

Kód	rozmary	m. j.
<b>28956</b>	1,05 x 25 m	ks
<b>289531</b>	1,05 x 100 m	ks
<b>28958</b>	1,65 x 50 m	ks
<b>28960</b>	2,1 x 100 m	ks
<b>28962</b>	2,1 x 25 m	ks

**Kotúč 130 g/m<sup>2</sup>**

Kód	rozmary	m. j.
<b>28916</b>	3,3 x 50 m	ks
<b>28921</b>	4,2 x 50 m	ks
<b>28926</b>	5,25 x 50 m	ks

**Príchytka na pletivo pod trávnu 10 cm**

Kód	balenie	m. j.
<b>28711</b>	100 ks	balík
<b>28713</b>	300 ks	balík
<b>28715</b>	500 ks	balík

hlavička 3 cm

## Kokosové rohože, plachtičky, Jutenon

### Kokosová rohož 350 g/m<sup>2</sup>



Kód	rozmery	m. j.
<b>311</b>	2 x 50 m	m <sup>2</sup>
<b>31</b>	2,4 x 50 m	m <sup>2</sup>

Protierózna plná 350 g/m<sup>2</sup>  
balenie 100 m<sup>2</sup>

### Kokosová rohož 400 g/m<sup>2</sup>



Kód	rozmery	m. j.
<b>3101</b>	2 x 50 m	m <sup>2</sup>

Protierózna 400 g/m<sup>2</sup>

### Jutové pásy



Kód	rozmery	m. j.
<b>366</b>	10 cm x 25 m	ks

### Geotextília biela



Kód	gramáž	rozmery	m. j.
<b>210001</b>	300 g/m <sup>2</sup>	2,2 x 50 m	m <sup>2</sup>
<b>210000</b>	300 g/m <sup>2</sup>	2 x 50 m	m <sup>2</sup>
<b>999106</b>	150 g/m <sup>2</sup>	2,2 x 50 m	m <sup>2</sup>
<b>5113162</b>	400 g/m <sup>2</sup>	2 x 50 m	m <sup>2</sup>

100 m<sup>2</sup> rolka - predaj na celé rolky

### Membrána proti prerastaniu koreňov



Kód	rozmery	m. j.
<b>9991054</b>	70 cm x 25 m	m <sup>2</sup>
<b>99910540</b>	100 cm x 25 m	m <sup>2</sup>

### Jutenon ECJ sieť 500 g/m<sup>2</sup>



Kód	rozmery	m. j.
<b>210090</b>	1,22 x 50 m/61 m <sup>2</sup>	ks

Protierózna 500 g/m<sup>2</sup>

### Prírodná mulčovačia textília



- vyrobená z jutového vlákna
- biologicky rozložiteľná
- obmedzuje rast buriny, zabraňuje erózií pôdy
- oproti klasickej netkanej textílii umožňuje ľahší prienik vody do pôdneho profilu a lepšiu evaporáciu

Kód	hustota	rozmery	m. j.
<b>210096</b>	300 g/m <sup>2</sup>	1 x 10 m	ks

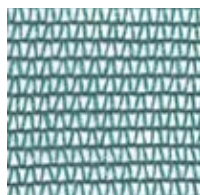
**ULTRALIGHTTEX 30 g/m<sup>2</sup>****30%**

Kód	rozmary	m. j.	
<b>28472</b>	1,5 x 50 m	ks	
<b>28477</b>	2 x 50 m	ks	
<b>28482</b>	3 x 50 m	ks	
<b>28487</b>	6 x 50 m	ks	
<b>28492</b>	9 x 50 m	ks	

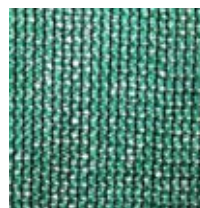
**LIGHTTEX 90 g/m<sup>2</sup>****80%**

Kód	rozmary	m. j.	kart.
<b>28500</b>	1 x 10 m	ks	6
<b>28502</b>	1 x 50 m	ks	-
<b>28574</b>	1,2 x 10 m	ks	6
<b>28575</b>	1,2 x 50 m	ks	-
<b>28504</b>	1,5 x 10 m	ks	6
<b>28506</b>	1,5 x 50 m	ks	-
<b>28508</b>	1,8 x 10 m	ks	6
<b>28511</b>	1,8 x 50 m	ks	-
<b>28541</b>	2 x 10 m	ks	6
<b>28543</b>	2 x 50 m	ks	-

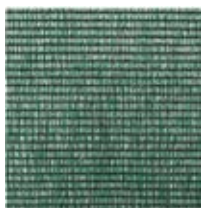
**MEDIUMTEX 160 g/m<sup>2</sup>****90%**

Kód	rozmary	m. j.	kart.
<b>28576</b>	1,2 x 10 m	ks	6
<b>28577</b>	1,2 x 50 m	ks	-
<b>28513</b>	1 x 10 m	ks	6
<b>28515</b>	1 x 50 m	ks	-
<b>28517</b>	1,5 x 10 m	ks	6
<b>28519</b>	1,5 x 50 m	ks	-
<b>28521</b>	1,8 x 10 m	ks	6
<b>28523</b>	1,8 x 50 m	ks	-
<b>28545</b>	2 x 10 m	ks	6
<b>28547</b>	2 x 50 m	ks	-

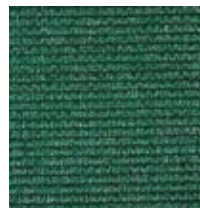
**GOLDTEX 230 g/m<sup>2</sup>****95%**

Kód	rozmary	m. j.	kart.
<b>28525</b>	1 x 10 m	ks	6
<b>28527</b>	1 x 50 m	ks	-
<b>28529</b>	1,2 x 10 m	ks	6
<b>28531</b>	1,2 x 50 m	ks	-
<b>28533</b>	1,5 x 10 m	ks	6
<b>28535</b>	1,5 x 50 m	ks	-
<b>28537</b>	1,8 x 10 m	ks	6
<b>28539</b>	1,8 x 50 m	ks	-
<b>28549</b>	2 x 10 m	ks	6
<b>28561</b>	2 x 50 m	ks	-

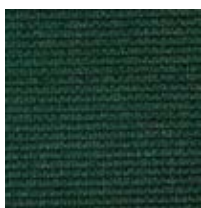
**SUPERTEX 260 g/m<sup>2</sup>****99%**

Kód	rozmary	m. j.	kart.
<b>28578</b>	1 x 10 m	ks	6
<b>28562</b>	1 x 50 m	ks	-
<b>28581</b>	1,5 x 10 m	ks	6
<b>28582</b>	1,5 x 50 m	ks	-
<b>28583</b>	1,8 x 10 m	ks	6
<b>28584</b>	1,8 x 50 m	ks	-
<b>28588</b>	2 x 10 m	ks	6
<b>28589</b>	2 x 50 m	ks	-

## Tieniace siete

### GREYTEX 160 g/m<sup>2</sup>

90%

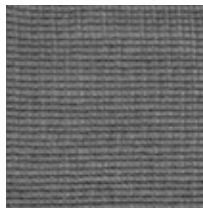

Kód	rozmery	m. j.	kart.
<b>28601</b>	1 x 10 m	ks	6
<b>28606</b>	1 x 50 m	ks	-
<b>28603</b>	1,5 x 10 m	ks	6
<b>28608</b>	1,5 x 50 m	ks	-
<b>28604</b>	1,8 x 10 m	ks	6
<b>28609</b>	1,8 x 50 m	ks	-
<b>28605</b>	2 x 10 m	ks	6
<b>28612</b>	2 x 50 m	ks	-

### BROWNTEX 160 g/m<sup>2</sup>

90%



Kód	rozmery	m. j.	kart.
<b>28591</b>	1 x 10 m	ks	6
<b>28596</b>	1 x 50 m	ks	-
<b>28593</b>	1,5 x 10 m	ks	6
<b>28598</b>	1,5 x 50 m	ks	-
<b>28594</b>	1,8 x 10 m	ks	6
<b>28599</b>	1,8 x 50 m	ks	-
<b>28595</b>	2 x 10 m	ks	6
<b>28602</b>	2 x 50 m	ks	-

### BRIDFIX príchytky

NEW



Kód	farba	bal.	m. j.
<b>28579</b>	zelená	50 ks	bal.
<b>285790</b>	šedá	50 ks	bal.
<b>285792</b>	hnedá	50 ks	bal.
<b>285794</b>	čierna	50 ks	bal.

### Úväz - šnúra k tieniacim sieťam



Kód	bal.
<b>283041</b>	3 cm x 50 m

## Plotové krycie pásy



Kód	rozmery	farba	hustota
<b>285110</b>	19 cm x 35 m	zelená	450 g/m <sup>2</sup>



Kód	rozmery	farba	hustota
<b>285120</b>	19 cm x 35 m	antracit	450 g/m <sup>2</sup>



## Sieť proti vtákom



Kód	rozmery	oko	m. j.
<b>19301</b>	2 x 5 m	19 x 19 mm	ks
<b>19303</b>	2 x 10 m	19 x 19 mm	ks
<b>19305</b>	2 x 50 m	19 x 19 mm	ks
<b>19302</b>	4 x 5 m	19 x 19 mm	ks
<b>19304</b>	4 x 10 m	19 x 19 mm	ks
<b>19306</b>	4 x 50 m	19 x 19 mm	ks

## Sieť podporná



Kód	rozmery	oko	m. j.
<b>18010</b>	1,2 x 10 m	10 x 10 cm	ks
<b>18007</b>	1,7 x 5 m	15 x 17 cm	ks
<b>18012</b>	1,7 x 10 m	15 x 17 cm	ks
<b>18033</b>	1,7 x 20 m	15 x 17 cm	ks
<b>18400</b>	1,7 x 100 m	15 x 17 cm	ks

## Príchytky na fólie



Kód	balenie	m. j.
<b>24000</b>	20 ks	bal.

## Vrecia

## Vreca tkané 50 kg



Kód	rozmer	m. j.
<b>28230</b>	56 x 115 cm	ks

## Vreca PE 150 mic



Kód	rozmer	farba	m. j.
<b>28870</b>	400 x 600 mm	transparent	ks
<b>28850</b>	560 x 1100 mm	transparent	ks
<b>28800</b>	560 x 1100 mm	čierne	ks

## Sieťovina paletizačná 5,7 kg



Kód	balenie	m. j.
<b>289010</b>	50 cm x 1500 m	ks

## Big-Bag



Kód	balenie	m. j.
<b>107070</b>	70 x 70 x 70 cm	ks
<b>109090</b>	90 x 90 x 110 cm	ks

## Plachty, laná

### Špagát jutový



Kód	hustota /hrúbka	dĺžka	bal.
<b>28339</b>	100 g/1,25 mm	100 m	10 ks
<b>28340</b>	200 g/1,25 mm	200 m	10 ks
<b>28342</b>	50 g/1,75 mm	33 m	42 ks
<b>28343</b>	100 g/1,75 mm	67 m	10 ks
<b>28344</b>	250 g/1,75 mm	166 m	8 ks
<b>28341</b>	500 g/1,75 mm	500 m	6 ks
<b>28351</b>	200 g/3,5 mm	60 m	10 ks
<b>28352</b>	500 g/3,5 mm	150 m	6 ks
<b>28353</b>	1000 g/4 mm	300 m	4 ks

### Špagát bavlna 40 g



Kód	hrúbka	dĺžka
<b>28371</b>	1,25 mm	63 m

### Špagát ľanový



Kód	hustota	dĺžka	bal.
<b>28408</b>	40 g	63 m	10 ks
<b>28409</b>	100 g	158 m	10 ks

### Špagát PP



Kód	hustota /hrúbka	dĺžka	bal.	m. j.
<b>28305</b>	100 g/2 mm	124 m	10 ks	ks
<b>28306</b>	250 g/2 mm	310 m	8 ks	ks
<b>28307</b>	500 g/2 mm	620 m	6 ks	ks
<b>28313</b>	250 g/2,3 mm	200 m	8 ks	ks
<b>28314</b>	500 g/2,3 mm	400 m	6 ks	ks
<b>28315</b>	1000 g/2,3 mm	800 m	4 ks	ks

### Špagát PP 5 kg



Kód	hrúbka	dĺžka	m. j.
<b>28322</b>	2,15 mm	5000 m	ks
<b>28323</b>	2,25 mm	4000 m	ks
<b>28324</b>	2,75 mm	3500 m	ks
<b>28326</b>	3,25 mm	2500 m	ks
<b>28327</b>	3,25 mm	2500 m	ks
<b>28328</b>	3,75 mm	2000 m	ks

### Špagát



Kód	názov	bal.	m. j.
<b>28304</b>	špagát PP 50 g 2 mm 7800 tex	62 m	ks
<b>283040</b>	špagát PP 100 g 2 mm 7800 tex	124 m	ks

### Lano polyamidové



Kód	balenie
<b>999012</b>	200 m

### Plachta PE štandard 65g



Kód	rozmer
<b>1260023</b>	2 x 3 m
<b>1260034</b>	3 x 4 m
<b>1260035</b>	3 x 5 m
<b>1260045</b>	4 x 5 m
<b>1260046</b>	4 x 6 m
<b>1260056</b>	5 x 6 m
<b>1260058</b>	5 x 8 m
<b>1260610</b>	6 x 10 m
<b>1260812</b>	8 x 12 m

### Flexibilný mäkký úväz pre rastliny



Kód	balenie
<b>1503083</b>	3,9 mm x 30 m

**Lyko**



Kód	hmotnosť
<b>5022880</b>	50 g
<b>5022881</b>	150 g

**Jutenon pás**



Kód	rozmer
<b>366</b>	10 cm x 25 m

**Oporný kôl morený**



Kód	popis	rozmer	bal.
<b>9990014</b>	Guľatý s hrotom	5/250 cm	330 ks/pal.
<b>9990017</b>	Guľatý s hrotom	5/250 cm	100 ks/pal.
<b>9990027</b>	Guľatý s hrotom	6/250 cm	100 ks/pal.
<b>9990037</b>	Spájací Polo	6/250 cm	200 ks/pal.

**Úväz - popruh čierny**



Kód	rozmer
<b>999020</b>	25 mm x 50 m
<b>999011</b>	35 mm x 50 m
<b>999022</b>	40 mm x 50 m
<b>999024</b>	50 mm x 25 m

**Bambusová tyč**



Kód	rozmer	bal.
<b>7509</b>	6 - 8 mm/90 cm	500 ks/bal.
<b>75091</b>	6 - 8 mm/90 cm	20 ks/bal.
<b>7512</b>	8 - 10 mm/120 cm	500 ks/bal.
<b>75121</b>	8 - 10 mm/120 cm	20 ks/bal.
<b>7515</b>	10 - 12 mm/150 cm	250 ks/bal.
<b>75151</b>	10 - 12 mm/150 cm	10 ks/bal.
<b>7518</b>	12 - 144 mm/180 cm	200 ks/bal.
<b>75181</b>	12 - 144 mm/180 cm	10 ks/bal.
<b>7524</b>	18 - 20 mm/240 cm	100 ks/bal.
<b>7529</b>	20 - 22 mm/300 cm	50 ks/bal.
<b>75210</b>	24 - 26 mm/210 cm	50 ks/bal.
<b>75240</b>	26 - 28 mm/240 cm	50 ks/bal.

**Ocelová záhradná tyč**

**NEW**



Kód	rozmer	bal.
<b>15029687</b>	0,8 x 60 cm	100 ks/bal.
<b>15029688</b>	1,1 x 90 cm	100 ks/bal.
<b>15029671</b>	1,1 x 120 cm	10 ks/bal.
<b>1502967</b>	1,1 x 150 cm	10 ks/bal.
<b>15029672</b>	1,1 x 180 cm	10 ks/bal.
<b>15029675</b>	1,6 x 150 cm	10 ks/bal.
<b>1502968</b>	1,6 x 180 cm	10 ks/bal.
<b>15029681</b>	1,6 x 210 cm	10 ks/bal.
<b>15029685</b>	2,0 x 180 cm	10 ks/bal.
<b>15029686</b>	2,0 x 210 cm	10 ks/bal.
<b>1502975</b>	2,0 x 240 cm	10 ks/bal.

**Záhradná tyč k rajčinám**



Kód	popis
<b>145044</b>	1,8 m - špirálová 7 mm komaxit strieborná

**Bambus štiepaný**



Kód	rozmer
<b>145410</b>	1 x 5 m
<b>145415</b>	1,5 x 5 m
<b>145420</b>	2 x 5 m

**Spojka 90° pre záhradné tyče**



Kód	rozmer
<b>1502985</b>	11 mm
<b>1502987</b>	16 mm

**Spojka nastaviteľná pre záhradné tyče**



Kód	rozmer
<b>1502995</b>	11 mm
<b>1502997</b>	16 mm

Vodný program



Kód	popis
<b>150024</b>	Pišťoľ prúdnicová PowerJet



Kód	popis
<b>150025</b>	Rýchlospojka na 1" hadicu PowerJet
<b>150026</b>	Rýchlospojka na 3/4" hadicu PowerJet



Kód	popis
<b>150028</b>	Medzikus na 2 rýchlospojky PowerJet



Kód	popis
<b>150029</b>	Medzikus na 2 rýchlospojky PowerJet - Standard



Kód	popis
<b>1500270</b>	Adaptér na vodovodný kohút 3/4" PowerJet
<b>1500271</b>	Adaptér na vodovodný kohút 1" PowerJet



Kód	popis
<b>150031</b>	Adaptér PowerJet - závit 3/4" VOZ



Kód	popis
<b>150027</b>	Adaptér na ventil 3/4" - 1" PowerJet



Kód	popis
<b>150033</b>	Pištoľ prúdnicová Standard



Kód	popis
<b>150034</b>	Rýchlospojka na 1/2" hadicu Standard
<b>150035</b>	Rýchlospojka na 3/4" hadicu Standard



Kód	popis
<b>150036</b>	Rýchlospojka stop na 1/2" hadicu Standard
<b>150037</b>	Rýchlospojka stop na 3/4" hadicu Standard



Kód	popis
<b>150038</b>	Rýchlospojka stop na 3/4" hadicu/3/4"VNZ



Kód	popis
<b>150039</b>	Rýchlospojka na 3/4" hadicu/3/4"VOZ



Kód	popis
<b>150041</b>	Adaptér na 1/2" hadicu/3/4"VOZ



Kód	popis
<b>150043</b>	Spojka na hadicu 1/2" - 1/2"
<b>150045</b>	Spojka na hadicu 3/4" - 3/4"
<b>150046</b>	Spojka na hadicu 1" - 1"



Kód	popis
<b>150047</b>	Redukovaná spojka na hadicu 1/2" - 3/4"
<b>150048</b>	Redukovaná spojka na hadicu 3/4" - 1"



Kód	popis
<b>1500231</b>	Rýchlospojka TPR 1/2" - 5/8"
<b>1500232</b>	Rýchlospojka TPR 3/4"
<b>1500233</b>	Rýchlospojka stop TPR 1/2" - 5/8"
<b>1500234</b>	Rýchlospojka stop TPR 3/4"



Kód	popis
<b>1500230</b>	Pištoľ prúdnicová nastaviteľná TPR

## Vodný program



Kód	popis
<b>150051</b>	Adaptér Standard - red. 1/2" - 3/4"VNZ
<b>150052</b>	Adaptér Standard - red. 3/4" - 1"VNZ



Kód	popis
<b>150049</b>	Kľbový adaptér Standard - 1" - 3/4"VNZ



Kód	popis
<b>150053</b>	Adaptér Standard - 1/2"VNZ
<b>150054</b>	Adaptér Standard - 3/4"VNZ
<b>150056</b>	Adaptér Standard - 1"VNZ'



Kód	popis
<b>1500560</b>	Medzikus - adaptér Standard - 1/2"VOZ
<b>150057</b>	Medzikus - adaptér Standard - 3/4"VOZ



Kód	popis
<b>150058</b>	Medzikus - adaptér Standard/Standard



Kód	popis
<b>150059</b>	Medzikus - adaptér pre 3 rýchlospojky Standard



Kód	popis
<b>150061</b>	Ventil - adaptér Standard - 3/4"VNZ



Kód	popis
<b>150062</b>	Ventil - adaptér 3/4"VOZ - 3/4"VNZ
<b>150063</b>	2x ventil - adaptér Standard - 3/4"VNZ



Kód	popis
<b>1500730</b>	Vodná pištoľ WL-EN54M regulovateľná



Kód	popis
<b>1500731</b>	Vodná pištoľ WL-EN55M 5-funkčná
<b>1500732</b>	Vodná pištoľ WL-EN56M 7-funkčná



Kód	popis
<b>150068</b>	Prietokomer, LCD displej, pracovný tlak 1 - 8 bar, max. 60°C voda, Standard

Kód	popis
<b>150064</b>	Rozdeľovací 4x ventil - adaptér Standard 1" - 3/4"VNZ



Kód	popis
<b>150066</b>	Sada 1/2" - pištoľ, 2x rýchlospojka, adaptér Standard - 1/2" - 3/4"VNZ

Kód	popis
<b>150067</b>	Sada 3/4" - pištoľ, 2x rýchlospojka, adaptér Standard - 3/4" - 1"VNZ



Kód	popis
<b>150073</b>	Sada tesnení 1/2", 3/4", 1" Standard O-ring, 6 ks v bal.

Kód	popis
<b>150074</b>	Vodná pištoľ kovová WATER CLICK nastaviteľná, Standard



Kód	popis
<b>150076</b>	Vodná pištoľ kovová WATER CLICK 5-funkčná, Standard

Kód	popis
<b>150077</b>	Vodná pištoľ kovová WATER CLICK 7-funkčná, Standard



Kód	popis
<b>1500712</b>	Časovač prietoku vody 3/4" - 1"

Kód	popis
<b>150072</b>	Tesnenie 3/4" s filtrom

## Vodný program



Kód	popis
<b>1500774</b>	Vodná pištoľ regulovateľná jednoduchá



Kód	popis
<b>150078</b>	Vodná pištoľ 5-funkčná QuickMultiSpray



Kód	popis
<b>150079</b>	Vodná pištoľ nastaviteľná Quick jednoduchá



Kód	popis
<b>1500801</b>	Vodná pištoľ multifunkčná Quick Exclusive



Kód	popis
<b>15008582</b>	Nastaviteľný prúdnicový postrekovač s ventilom TPR



Kód	popis
<b>1500804</b>	Postrekovač pulzný regulovateľný, priemer postreku 15 m



Kód	popis
<b>15008581</b>	Pulzný postrekovač Aqua Jet dostrek 14 - 28 m



Kód	popis
<b>1500803</b>	Postrekovač pulzný bez regulácie, priemer postreku 27 m



Kód	popis
<b>1502958</b>	Záhradný ventil dvojcestný M 1/2", 2x M 3/4"



Kód	popis
<b>1502959</b>	Záhradný ventil dvojcestný M 3/4", 2x M 1"



Kód	popis
<b>150081</b>	Postrekovač stacionárny 8 funkčný, Standard



Kód	popis
<b>150083</b>	Postrekovač výkyvný, 18 trysiek, pokrytie 375 m <sup>2</sup> , Standard



Kód	popis
<b>150082</b>	Postrekovač rotačný 3 ramenný, Standard



Kód	popis
<b>150084</b>	Postrekovač výkyvný, plast/hliník, 18 trysiek, 334 m <sup>2</sup> , Standard



Kód	popis
<b>1500822</b>	Postrekovač rotačný na podstavci, 4-funkčný, regulovateľný, priemer dostreku d 21 m



Kód	popis
<b>1500845</b>	Postrekovač pulzný Triton, trojšpic, plast, priemer dostreku d 26,6 m



Kód	popis
<b>1500842</b>	Postrekovač pulzný regulovateľný, kovový špic, priemer dostreku d 26,2 m



Kód	popis
<b>150650</b>	Trojnožka nastaviteľná 57 - 90 cm s postrekovačom, dostrek 13,5 m



Kód	popis
<b>150660</b>	Trojnožka nastaviteľná 75 - 110 cm, závit 3/4" vonk.
<b>150670</b>	Trojnožka nastaviteľná 75 - 110 cm, závit 1" vonk.

## Vodný program



Kód	popis
<b>1500853</b>	Postrekovač na tyči s ventilom regulácie prietoku, sitko Pro, 88 cm



Kód	popis
<b>1500847</b>	Postrekovač regulovateľný, špic plast, priemer dostreku d 10 m



Kód	popis
<b>1500858</b>	Postrekovač tyčový, kovový s ventilom, sitko, 90 cm
<b>15008580</b>	Postrekovač tyčový, kovový s ventilom, sitko, 75 cm



Kód	popis
<b>1500852</b>	Postrekovač na tyči s ventilom regulácie prietoku, sitko Exclusive, 74 cm



Kód	popis
<b>1506040</b>	Geka spojka, IMT zátka, Standard



Kód	popis
<b>1506011</b>	Geka spojka IMT 1/2" - 13 mm hadicová
<b>1506013</b>	Geka spojka IMT 3/4" - 19 mm hadicová
<b>1506014</b>	Geka spojka IMT 1" - 25 mm hadicová
<b>1506016</b>	Geka spojka IMT 1 1/4" - 32 mm hadicová



Kód	popis
<b>1506021</b>	Geka spojka IMT 1/2" vnútorný závit
<b>1506023</b>	Geka spojka IMT 3/4" vnútorný závit
<b>1506024</b>	Geka spojka IMT 1" vnútorný závit
<b>1506026</b>	Geka spojka IMT 1 1/4" vnútorný závit



Kód	popis
<b>1506031</b>	Geka spojka IMT 1/2" vonkajší závit
<b>1506033</b>	Geka spojka IMT 3/4" vonkajší závit
<b>1506034</b>	Geka spojka IMT 1" vonkajší závit
<b>1506036</b>	Geka spojka IMT 1 1/4" vonkajší závit



Kód	popis
<b>1506050</b>	Geka spojka IMT T-kus Standard



Kód	popis
<b>1506060</b>	Tesnenie pre gecka spojky IMT Standard



Kód	popis
<b>150752</b>	BR-2120 rýchlospojka na ½" hadicu
<b>150754</b>	BR-2130 rýchlospojka na ¾" hadicu

Kód	popis
<b>150756</b>	BR-2196 adaptér ½"
<b>150758</b>	BR-2195 adaptér ¾"
<b>150760</b>	BR-2197 adaptér 1"



Kód	popis
<b>150764</b>	BR-2200 medzikus - adaptér

Kód	popis
<b>150772</b>	BR-2185 medzikus - adaptér ¾"



Kód	popis
<b>150762</b>	BR-2134 rotačný adaptér L ¾"

Kód	popis
<b>150766</b>	BR-2012 spojka na hadicu ½"
<b>150768</b>	BR-2058 spojka na hadicu 5/8"
<b>150770</b>	BR-2034 spojka na hadicu ¾"



Kód	popis
<b>150774</b>	BR-2234 2x ventil ¾" VOZ - ¾" VNZ

Kód	popis
<b>150750</b>	BR-4710 pištoľ prúdnicová



Kód	popis
<b>145223</b>	Hadicová koncovka ½" hollander
<b>145224</b>	Hadicová koncovka ¾" hollander
<b>145225</b>	Hadicová koncovka 1" hollander



Kód	popis
<b>145220</b>	Hadicová spojka ½" hollander
<b>145221</b>	Hadicová spojka ¾" hollander
<b>145222</b>	Hadicová spojka 1" hollander



Kód	popis
<b>145229</b>	Rozprašovač ½" - ¾"



Kód	popis
<b>145226</b>	Hadicová redukcia ¾" - ½" hollander
<b>145227</b>	Hadicová redukcia 1" - ¾" hollander
<b>145228</b>	Hadicová redukcia 1" - ½" hollander



Kód	popis
<b>145622</b>	Hadicová spona 12 - 20 mm NEREZ
<b>145623</b>	Hadicová spona 16 - 25 mm NEREZ
<b>145624</b>	Hadicová spona 20 - 32 mm NEREZ
<b>145625</b>	Hadicová spona 25 - 40 mm NEREZ
<b>145626</b>	Hadicová spona 30 - 45 mm NEREZ
<b>145627</b>	Hadicová spona 32 - 50 mm NEREZ



Kód	popis
<b>145615</b>	Hadicová spona 110 - 130 mm
<b>145619</b>	Hadicová spona 150 - 170 mm

Okrasné umývadlá a studne

**VERONA** - nástenné umývadlo + kohútik 1/2"  
Rozmery: 66 x 39 x 24 cm



Kód	farba
95000	zeleno/biela
95010	zelená
95015	biela
95020	čierna
95030	antické zlato
95032	antické striebro
95040	granit
95050	antický bronz
95060	kameň
95070	kladivkový bronz
95080	kladivkové striebro
95090	antická zelená

 **LEN NA OBJEDNÁVKU**

**FIRENZE** - studňa + kohútik 3/4"  
Rozmery: 89 x 48 x 32 cm



 **LEN NA OBJEDNÁVKU**

Kód	farba
95210	zelená
95220	kladivkové striebro
95230	antický bronz
95235	antické striebro
95240	kladivkový bronz
95250	čierna
95260	kameň
95270	kladivkové zlato

**VIENNA** - nástenné umývadlo + kohútik 1/2"  
Rozmery: 83 x 47 x 26 cm



 **LEN NA OBJEDNÁVKU**

Kód	farba
95100	zeleno/biela
95110	zelená
95120	čierna
95130	antické zlato
95135	antické striebro
95140	granit
95150	antický bronz
95160	kameň

**ROMA** - studňa + kohútik 1/2"  
Rozmery: 98 x 32 x 48 cm



 **LEN NA OBJEDNÁVKU**

Kód	farba
95600	biela
95610	zelená
95620	čierna
95625	kladivkové striebro
95630	antické zlato
95632	antické striebro
95635	granit
95637	kladivkový bronz
95638	kladivkové zlato
95640	antický bronz
95645	antik zelená
95650	kameň
95660	granit

**SIENA** - nástenné umývadlo + kohútik 1/2"  
Rozmery: 83 x 51 x 36 cm



 **LEN NA OBJEDNÁVKU**

Kód	farba
95200	antické zlato
95690	antické striebro

**PISA** - studňa + kohútik 1/2"  
Rozmery: 89 x 32 x 48 cm



 **LEN NA OBJEDNÁVKU**

Kód	farba
95665	čierna
95666	antické zlato
95667	kladivkový bronz
95668	antický bronz



Záhradné studne

TRIANGLE



Kód	farba
<b>00400B</b>	bronz
<b>00400G</b>	šedá
<b>00400V</b>	zelená

TOTEM



Kód	farba
<b>00407G</b>	šedá
<b>00407N</b>	matná čierna
<b>00407R</b>	koralovo-červená

LOOP

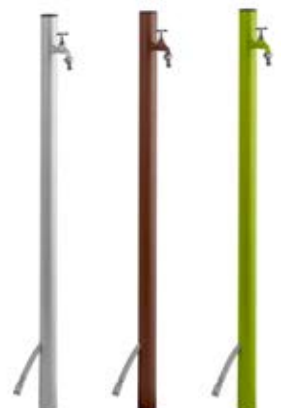

Kód	farba
<b>00409B</b>	biela
<b>00409C</b>	hrdzavo-hnedá
<b>00409VS</b>	pastelovo-zelená



Držiak - kotvenie pre studne  
série 400 - 407 - 409



Kód	popis
<b>000135</b>	držiak pre kotvenie

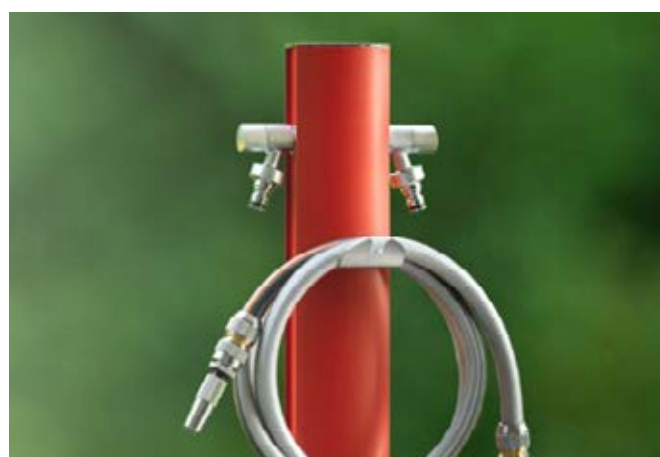



Kód	popis	pripojenie	m. j.
<b>93010</b>	mosadz	1/2"	ks



Kód	popis	pripojenie	m. j.
<b>93011</b>	mosadz	1/2"	ks



Kód	popis	pripojenie	m. j.
<b>93012</b>	mosadz	1/2"	ks



Kód	popis	pripojenie	m. j.
<b>93013</b>	chróm	3/4"	ks



Kód	popis	pripojenie	m. j.
<b>93014</b>	mosadz	3/4"	ks



Kód	popis	pripojenie	m. j.
<b>93020</b>	čierna/bronzová	1/2"	ks



Kód	popis	pripojenie	m. j.
<b>93022</b>	čierna/strieborná	1/2"	ks



Kód	popis	pripojenie	m. j.
<b>93026</b>	čierna/zelená	1/2"	ks



Kód	popis	objem	m. j.
<b>1503160</b>	zavlažovací vak	75 l	ks

- Vak vyrobený s odolného PE, max. objem vody 75 l
- Zipsom je možné spojiť dva vaky, v tom prípade je max. objem 100 l
- Doba vykvákavania 5 hod

Hadice, príslušenstvo

Záhradná hadica Fitt žltá



Kód	priemer	dĺžka	m. j.
154801	1/2"	25 bm	ks
154802	3/4"	25 bm	ks
154803	1"	25 bm	ks

Záhradná hadica SUN



Kód	priemer	dĺžka	m. j.
154821	1/2"	25 bm	ks
154822	3/4"	25 bm	ks

Záhradná hadica Fitt modrá



nárazový tlak 25 - 30 bar

Kód	priemer	dĺžka	m. j.
154811	1/2"	25 bm	ks
154812	3/4"	25 bm	ks
154813	1"	25 bm	ks
154815	1/2"	50 bm	ks
154816	3/4"	50 bm	ks

Záhradná hadica Fitt KIUMA - set



nárazový tlak 20 bar

Kód	priemer	dĺžka	m. j.
154824	1/2"	20 bm	ks

Samonavíjací box s hadicou WL



Kód	pripojenie	dĺžka	m. j.
15029420	1/2"	20 m	ks
15029435	1/2"	35 m	ks

Vozík na hadicu SOLID ZINC CHROM



Kód	pripojenie	dĺžka	m. j.
1502901	3/4"	50 m	ks

Vozík na hadicu AQUA REEL



Kód	pripojenie	dĺžka	m. j.
150292	1/2"	45 m	ks

Držiak nástenný kovový ECO WF114



Kód	m. j.
150301	ks

Osviežovače a zavlažovacie sety

Osviežujúci set



Kód	rozmer	m. j.
95806	15 m	ks
95810	náhradná hadička	ks
95820	náhradné trysky	ks
95830	Osviežujúci set 7,5 m	ks
95840	Osviežujúci set 15 m	ks

Osviežujúci set



- 4+1 trysky s ohybným kĺbom
- Vodnou parou schladí vzduch až o 10 °C.

Kód	rozmer	m. j.
95830	7,5 m	ks
95840	15 m	ks

Časový spínač



Kód	pripojenie	m. j.
95808	1" a ¾"	ks

Zavlažovací set WATER FLOW DRIP

50 m hadica



Kód	m. j.
1503100	ks

Zavlažovací set MÔJ BALKÓN

15 m hadica



Kód	m. j.
352055	ks

Zavlažovací set ZELENINOVÁ ZÁHRADA

25 m hadica



Kód	m. j.
352057	ks

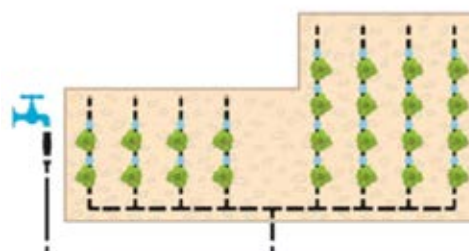

QuickFit

FISKARS®



Kód	popis
<b>31000687</b>	Nôž na špáry

Kód	popis
<b>31000657</b>	Kefa na špáry QuikFit



Kód	popis
<b>31000659</b>	Hrable QuikFit na lístie úzke

Kód	popis
<b>3135013</b>	Hrable široké na lístie



Kód	popis
<b>31000660</b>	Hrable na lístie ľahké (L)

Kód	popis
<b>31000643</b>	Hrable QuikFit univerzálne



Kód	popis
<b>3135512</b>	Hrable (16 hrotov)

Kód	popis
<b>3135513</b>	Hrable prevzdušňovacie



Kód	popis
<b>3135514</b>	Hrable široké 58 cm

Kód	popis
<b>3135533</b>	Metla na terasy QuikFit

## QuickFit

FISKARS®



Kód	popis
<b>3136001</b>	Násada Graphite



Kód	popis
<b>3136032</b>	Násada teleskopická Graphite (L)



Kód	popis
<b>3136042</b>	Násada teleskopická (M)



Kód	popis
<b>3136503</b>	Motyčka



Kód	popis
<b>3136525</b>	Univerzálne nožnice



Kód	popis
<b>3136527</b>	Píla prerezávacía zahnutá

## Sekery



Kód	popis
<b>31015617</b>	Sekera X5 XS



Kód	popis
<b>31015618</b>	Sekera X7 XS



Kód	popis
<b>31015619</b>	X10 S

Náradie FISKARS

FISKARS®



Kód	popis
<b>31003685</b>	Vidly Xact veľké



Kód	popis
<b>31001579</b>	Lopata Ergonomic



Kód	popis
<b>3131400</b>	Rýľ Ergonomic, rovný



Kód	popis
<b>3131410</b>	Rýľ Ergonomic, špicatý



Kód	popis
<b>3136500</b>	Motyka ľahká



Kód	popis
<b>3135510</b>	Hrable ľahké záhradné

Záhradné nožnice



Kód	popis
<b>145029</b>	Nožnice NEREZ, aluminium



Kód	popis
<b>145095</b>	Záhradné nožnice WINLAND 20 cm 3130 TW



Kód	popis
<b>145098</b>	Záhradné nožnice WINLAND 22 cm japonská oceľ



Kód	popis
<b>145099</b>	Záhradné nožnice WINLAND 19 cm japonská oceľ

Záhradné nožnice



Kód	popis
<b>145000</b>	Nožnice PROFI na konáre oblé 75 cm
<b>145001</b>	Nožnice PROFI na konáre oblé 71 cm



Kód	popis
<b>145005</b>	Nožnice PROFI prevodové 58 cm vlnité ostrie 23 cm
<b>145006</b>	Nožnice PROFI prevodové 58 cm rovné ostrie 23 cm



Kód	popis
<b>145009</b>	Nožnice HOBBY vlnité ostrie 51 cm



Kód	popis
<b>145011</b>	Nožnice na trávú pevné 30 cm



Kód	popis
<b>145012</b>	Nožnice na trávú otočné 180° 37 cm



Kód	popis
<b>145015</b>	Nožnice pružinové rovné



Kód	popis
<b>145016</b>	Nožnice pružinové oblé



Kód	popis
<b>145018</b>	Záhradné nožnice kované



Kód	popis
<b>145025</b>	Nožnice PROFI hliník s aretáciou 20 cm



Kód	popis
<b>145027</b>	Nožnice PROFI kov s rohatkou

Nožnice Felco



Kód	popis
<b>12512</b>	Nožnice záhradnícke Felco 7



Kód	popis
<b>12510</b>	Nožnice záhradnícke Felco 8



Kód	popis
<b>12515</b>	Nožnice záhradnícke Felco 6



Kód	popis
<b>12516</b>	Nožnice záhradnícke Felco 13



Kód	popis
<b>12520</b>	Nožnice záhradnícke Felco 11



Kód	popis
<b>12521</b>	Nožnice záhradnícke Felco 2



Kód	popis
<b>12525</b>	Nožnice záhradnícke Felco 9 pre ľavákov



Kód	popis
<b>125251</b>	Nožnice záhradnícke Felco 160S



Kód	popis
<b>125250</b>	Nožnice záhradnícke Felco 160L



Kód	popis
<b>125292</b>	Puzdro pravá koža - kónické FELCO 912

Puzdra Felco, nožnice Archman



Kód	popis
<b>125290</b>	Puzdro umelá koža - kónické FELCO 913

Kód	popis
<b>125291</b>	Puzdro pravá koža - FELCO 910

Nožnice záhradnícke Archman



Kód	popis
<b>12530</b>	art. 1

Kód	popis
<b>12540</b>	art. 10

Kód	popis
<b>12560</b>	art. 4

Náradie Truper



Kód	popis
<b>3130005</b>	Hrable - hliníkové s tepelnou úpravou, 760 mm šírka, 168 cm rúčka

Kód	popis
<b>3130010</b>	Hrable - hliníkové s tepelnou úpravou, 914 mm šírka, 208 cm rúčka



Kód	popis
<b>3130020</b>	Rýľ úzky, 14 x 41 cm, 76,5 cm sklolaminát rúčka

Kód	popis
<b>3130040</b>	Lopata - ryhovač 10 cm šírka, 122 cm sklolaminát rúčka



Kód	popis
<b>3130090</b>	Ručný bager/kliešťové rýpadlo, 15,3 x 23 cm, 122 cm sklolaminát rúčka

Kód	popis
<b>3130080</b>	Rýľ mini, 46 cm rúčka

FISKARS®



Kód	popis
<b>31000615</b>	Skladacia píla Plus SW68

Kód	popis
<b>31000616</b>	Skladacia píla Plus SW69



Kód	popis
<b>3120740</b>	Ostrič nožov a sekier Xsharp

Kód	popis
<b>3125880</b>	Žabka záhradnícka



Kód	popis
<b>3125900</b>	Nôž očkovací

Kód	popis
<b>31000726</b>	Lopatka Fiskars Premium



Kód	popis
<b>31000727</b>	Lopatka Fiskars Premium na presádzanie

Kód	popis
<b>31000728</b>	Kultivátor Fiskars Premium



Kód	popis
<b>31001733</b>	Krompáč záhradný 200 ErgoComfort

Kód	popis
<b>31020126</b>	Vytrhávač buriny Xact

Záhradné nožnice a príslušenstvo FISKARS



Kód	popis
<b>31000583</b>	Nožnice PowerGear Steel na silné konáre LX94 (M), dvojčepelové

FISKARS®



Kód	popis
<b>31000809</b>	Nožnice univerzálne profi Cuts&More



Kód	popis
<b>31001550</b>	Nožnice PowerGear na silné konáre prevodové, jednočepelové (M)



Kód	popis
<b>31023624</b>	Záhradné nožnice univerzálne teleskopické PowerGear X UPX86



Kód	popis
<b>31019197</b>	Nožnice univerzálne veľké 21 cm čierne



Kód	popis
<b>3111960</b>	Nožnice záhradné profesionálne



Kód	popis
<b>3114770</b>	Nožnice na živý plot HSX92



Kód	popis
<b>31013565</b>	Nožnice SmartFit na živý plot, teleskopické HS86



Kód	popis
<b>31026285</b>	Čepel a skrutky pre nožnice L104, L108, LX94, LX98, L78, L94 a L98



Kód	popis
<b>31023633</b>	Prerezávacía píłka pre záhradné nožnice UPX86 a UPX82

Náradie



Kód	popis
<b>112130</b>	Pásmo sklolaminátové 30 m (púzdro)



Kód	popis
<b>116034</b>	Odlamovací nôž FESTA 25 mm SX2500 N



Kód	popis
<b>116218</b>	Nôž vrubľovací



Kód	popis
<b>116219</b>	Nôž očkovací



Kód	popis
<b>116220</b>	Nôž štepársky



Kód	popis
<b>123014</b>	Silonové lano 8 mm x cca 40 - 50 m biele



Kód	popis
<b>123950</b>	Viazacia páska 120 x 2,5 mm, 50 ks, čierna
<b>123951</b>	Viazacia páska 200 x 3,6 mm, 50 ks, čierna
<b>123952</b>	Viazacia páska 250 x 3,6 mm, 50 ks, čierna



Kód	popis
<b>138944</b>	Varovacia páska 250M ZÁKAZ VSTUPU

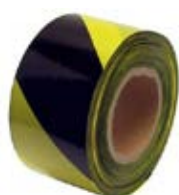

Kód	popis
<b>138946</b>	Varovacia páska 250M čierna-žltá



Kód	popis
<b>142210</b>	Viazací drôt 1,0 mm x 100 m pozinkovaný
<b>142214</b>	Viazací drôt 1,4 mm x 50 m pozinkovaný



Kód	popis
<b>145043</b>	Viazací drôt 30 m zelený



Kód	popis
<b>142244</b>	Viazací drôt 1,4 mm x 50 m zelený



Kód	popis
<b>1502970</b>	Podložka pod koleno 40 x 20 x 2 cm



Kód	popis
<b>139165</b>	Murárska nádoba obdĺžniková 65 l 64 x 33 x 27 cm
<b>139190</b>	Murárska nádoba obdĺžniková 80 l 70 x 40 x 28 cm



Kód	popis
<b>139045</b>	Murárska nádoba kruhová 45 l
<b>139065</b>	Murárska nádoba kruhová 65 l
<b>139090</b>	Murárska nádoba kruhová 90 l

## Rukavice



Kód	popis	velkosť
<b>438362</b>	polyuretan Pure Gray	8"
<b>438364</b>	polyuretan Pure Gray	10"



Kód	popis	velkosť
<b>438304</b>	guma Nitrox mint	8"



Kód	popis	velkosť
<b>438182</b>	latex Perfect Grip	8"
<b>438186</b>	latex Perfect Grip	10"
<b>438188</b>	latex Perfect Grip	11"



Kód	popis	velkosť
<b>438220</b>	latex Classic plus	9"
<b>438222</b>	latex Classic plus	10"
<b>438224</b>	latex Classic plus	11"



Kód	popis	velkosť
<b>438240</b>	guma Nitrox	8"
<b>438242</b>	guma Nitrox	10"
<b>438244</b>	guma Nitrox	11"



Kód	popis	velkosť
<b>438280</b>	Nitrox Flowers	6"
<b>438284</b>	Nitrox Flowers	8"



Kód	popis	velkosť
<b>438120</b>	Orange Latex	2"
<b>438122</b>	Orange Latex	3"
<b>438124</b>	Orange Latex	4"
<b>438126</b>	Orange Latex	5"
<b>438128</b>	Orange Latex	6"



Kód	popis	velkosť
<b>438140</b>	Kitty	4"



Kód	popis	velkosť
<b>438250</b>	Grizzly - zimné	10"
<b>438252</b>	Grizzly - zimné	11"



Kód	popis	velkosť
<b>438380</b>	VERDE	9"
<b>438382</b>	VERDE	10"



Kód	popis	velkosť
<b>919908</b>	BONASIA FH CUT 3 PU 15 g	8"
<b>919909</b>	BONASIA FH CUT 3 PU 15 g	9"
<b>919910</b>	BONASIA FH CUT 3 PU 15 g	10"
<b>919911</b>	BONASIA FH CUT 3 PU 15 g	11"



Kód	popis	velkosť
<b>339909</b>	CORAX FH kombinované	9"
<b>339912</b>	CORAX FH kombinované	11"
<b>339913</b>	CORAX FH kombinované	10"

## Rukavice



Kód	popis	velkosť
<b>2999100</b>	Rukavice PALAWAN s blistrom	10"
<b>2999101</b>	Rukavice PALAWAN s blistrom	9"



Kód	popis	velkosť
<b>809909</b>	EPOPS FH kombinované	9"
<b>809910</b>	EPOPS FH kombinované	10"
<b>809911</b>	EPOPS FH kombinované	11"



Kód	popis	velkosť
<b>8587070</b>	PINTAIL plet. nylon hnedá/zelená	7"
<b>8587080</b>	PINTAIL plet. nylon hnedá/zelená	8"
<b>8587090</b>	PINTAIL plet. nylon hnedá/zelená	9"



Kód	popis	velkosť
<b>853907</b>	PINTAIL plet. nylon navy/sv. fialová	7"
<b>853908</b>	PINTAIL plet. nylon navy/sv. fialová	8"



Kód	popis	velkosť
<b>329909</b>	TETRAX FH nylon. latex	9"
<b>329910</b>	TETRAX FH nylon. latex	10"
<b>329911</b>	TETRAX FH nylon. latex	11"



Kód	popis	velkosť
<b>299836</b>	Návlek POCHARD na ruku, kevlar	36 cm
<b>299856</b>	Návlek POCHARD na ruku, kevlar	56 cm

## Náhrobné sviečky a náhradné náplne do kahancov

## Náhrobná sviečka NR3LS biela



Kód	priemer	výška	doba horenia	m. j.
<b>720100</b>	60 mm	120 mm	36 hod	ks

## Náhrobná sviečka NR3LS červená



Kód	priemer	výška	doba horenia	m. j.
<b>720101</b>	60 mm	120 mm	36 hod	ks

## Náhradná náplň RP1 parafínová biela



Kód	priemer	výška	doba horenia	m. j.
<b>720102</b>	50 mm	90 mm	20 hod	ks

## Náhradná náplň RP15 parafínová biela



Kód	priemer	výška	doba horenia	m. j.
<b>720103</b>	50 mm	120 mm	34 hod	ks

## Náhradná náplň RP2 parafínová biela



Kód	priemer	výška	doba horenia	m. j.
<b>720104</b>	57 mm	110 mm	45 hod	ks

## Náhradná náplň RP3 parafínová biela



Kód	priemer	výška	doba horenia	m. j.
<b>720105</b>	50 mm	145 mm	68 hod	ks

## Náhradná náplň RP4 parafínová biela



Kód	priemer	výška	doba horenia	m. j.
<b>720106</b>	57 mm	175 mm	91 hod	ks

## Náhradná náplň RP5 parafínová biela



Kód	priemer	výška	doba horenia	m. j.
<b>720107</b>	67	195 mm	113 hod	ks

## Náhradná náplň RP7 parafínová biela



Kód	priemer	výška	doba horenia	m. j.
<b>720108</b>	67 mm	220 mm	148 hod	ks

## Náhradná náplň RP8 parafínová biela



Kód	priemer	výška	doba horenia	m. j.
<b>720109</b>	71	220 mm	170 hod	ks

## Náhradné náplne do kahancov

### Náhradná náplň RP110H parafínová biela



Kód	priemer	výška	doba horenia	m. j.
<b>720110</b>	67 mm	220 mm	110 hod	ks

### Náhradná náplň RP6W parafínová biela



Kód	priemer	výška	doba horenia	m. j.
<b>720111</b>	75	180 mm	135 hod	ks

### Náhradná náplň č. 40 bez palmového oleja biela



Kód	priemer	výška	doba horenia	m. j.
<b>720120</b>	52 mm	64 mm	18 hod	bal

### Náhradná náplň č. 40 bez palmového oleja červená



Kód	priemer	výška	doba horenia	m. j.
<b>720121</b>	52 mm	64 mm	18 hod	bal

### Náhradná náplň RC2 olejová biela



Kód	priemer	výška	doba horenia	m. j.
<b>720122</b>	48 mm	95 mm	40 hod	ks

### Náhradná náplň RC2 olejová červená



Kód	priemer	výška	doba horenia	m. j.
<b>720123</b>	48 mm	95 mm	40 hod	ks

### Náhradná náplň RC7 olejová biela



Kód	priemer	výška	doba horenia	m. j.
<b>720124</b>	67 mm	177 mm	140 hod	ks

### Náhradná náplň RC8 olejová biela



Kód	priemer	výška	doba horenia	m. j.
<b>720125</b>	66 mm	215 mm	170 hod	ks

## ZÁHRADNÉ OSVETLENIE 12 V

## Zapojenie LIGHTPRO

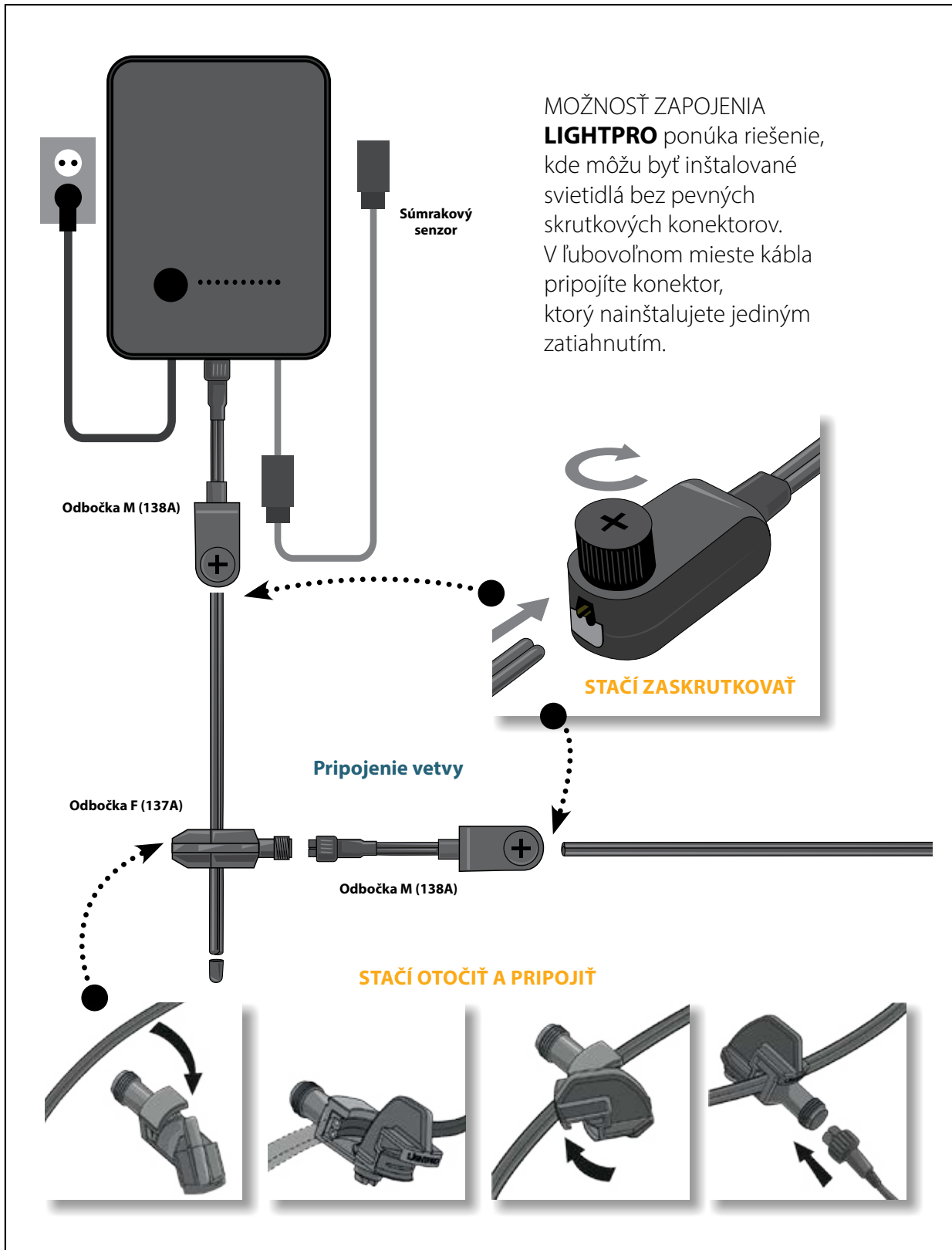



Osvetlenie stĺpikové Garden Lights



**Arco 40 Smart (Zigbee)**



Kód	popis
<b>1806451</b>	405 x 65 mm (v x š) LED 5 W RGB



**Arco 40**

Kód	popis
<b>180645</b>	405 x 64 mm (v x š), hliník LED 2,6 W teplá biela



**Reno**

Kód	popis
<b>180701</b>	620 x 95 mm (v x š) LED 6 W teplá biela



**Kolossos**

Kód	popis
<b>180345</b>	600 x 110 mm (v x š) LED 1,5 W biela



**Limosa 70**

Kód	popis
<b>180241</b>	680 x 120 mm (v x š) LED 3,5 W teplá biela



**Lunia**



Kód	popis
<b>180053</b>	440 x 60 mm (v x š) LED 1 W



**Silia**



Kód	popis
<b>180061</b>	600 x 60 mm (v x š) LED 1 W teplá biela



**Rune**

Kód	popis
<b>180059</b>	555 x 127 mm (v x š) LED 1,8 W teplá biela



**Dax**

Kód	popis
<b>180042</b>	780 x 160 mm (v x š) LED 1,8 W teplá biela



**Linum**

Kód	popis
<b>180115</b>	160 x 60 mm (v x š) LED 2 W teplá biela



Možnosť prepínania:  
teplá / studená biela



LEN NA  
OBJEDNÁVKU

Osvetlenie stípkové Garden Lights



**Deva**



Kód	popis
<b>180043</b>	457 x 105 mm (v x š) LED 1,8 W



**Atera**

Kód	popis
<b>180038</b>	617 x 105 mm (v x š) LED 1,8 W teplá biela



**Ceto**



Kód	popis
<b>180041</b>	440 x 190 mm (v x š) LED 2 W teplá biela

Osvetlenie stípkové LIGHTPRO



**Barite 40**

Kód	popis
<b>180500</b>	405 x 65 mm (v x š) LED 2,6 W teplá biela



**Barite 60**

Kód	popis
<b>180350</b>	575 x 65 mm (v x š) LED 2,6 W teplá biela



**Eros Lo**

Kód	popis
<b>180661</b>	500 x 115 mm (v x š) LED 3,5 W teplá biela



**Eros Hi**

Kód	popis
<b>180662</b>	870 x 115 mm (v x š) LED 3,5 W teplá biela



**Alon**

Kód	popis
<b>180004</b>	700 x 160 mm (v x š) LED 3,3 W teplá biela



Možnosť prepínania:  
teplá / studená biela



LEN NA  
OBJEDNÁVKU

## Osvetlenie stípkové LIGHTPRO



## Oberon Smart (Zigbee)



Kód	popis
<b>180008</b>	665 x 64 mm (v x š) LED 4,9 W RGB



## Oberon Hi

Kód	popis
<b>180007</b>	665 x 64 mm (v x š) LED 4 W teplá biela



## Oberon Lo

Kód	popis
<b>180006</b>	420 x 64 mm (v x š) LED 4 W teplá biela



## Oberon DL

Kód	popis
<b>180680</b>	600 x 110 mm (v x š) LED 9 W teplá biela



## Erba

Kód	popis
<b>180002</b>	905 x 20 mm (v x š) LED 1,1 W teplá biela



## Erba Mid

Kód	popis
<b>180003</b>	734 x 20 mm (v x š) LED 1,1 W teplá biela

## Bodové svetlá Garden Lights

### Focus Smart (Zigbee)



Kód	popis
<b>181034</b>	180 x 80 mm (v x š) LED 5W RGB

### Arcus



Kód	popis
<b>180297</b>	120 x 60 mm (v x š) LED 5 W teplá biela

### Arcus Smart (Zigbee)



Kód	popis
<b>181035</b>	120 x 60 mm (v x š) LED 5 W RGB

### Protego



Kód	popis
<b>180507</b>	140 x 120 mm (v x š) LED 5 W teplá biela

### Arigo



Kód	popis
<b>180362</b>	125 x 90 mm (v x š) LED 2,6 W teplá biela

### Flood 20



Kód	popis
<b>180601</b>	150 x 154 mm (v x š) LED 20 W teplá biela

### Flood 12



Kód	popis
<b>180600</b>	150 x 154 mm (v x š) LED 12 W teplá biela

### Neso



Kód	popis
<b>2606061</b>	220 x 70 mm (v x š) LED 2 W teplá biela

**Catalpa**



Kód	popis
<b>180040</b>	120 x 80 mm (v x š) Power LED 2,6 W teplá biela

**Alder**



Kód	popis
<b>180000</b>	120 x 40 mm (v x š) Power LED 1,8 W teplá biela

**Lapis**



Kód	popis
<b>180302</b>	110 x 145 mm (v x š) LED 2,6 W teplá biela

**Lapis SET**



SET

Kód	popis
<b>180307</b>	110 x 145 mm (v x š) LED 2,6 W teplá biela

**Corvus**



Kód	popis
<b>180245</b>	210 x 89 mm (v x š) LED 5 W teplá biela

**Raf**



Kód	popis
<b>180058</b>	139 x 95 (v x š) LED 1,8 W teplá biela

**Lovi**



Kód	popis
<b>180052</b>	122 x 58 (v x š) LED 1,8 W teplá biela

**Minus**



Kód	popis
<b>180230</b>	70 x 45 mm (v x š) LED 2 W teplá biela

## Bodové svetlá LIGHTPRO

### Castor SMART (Zigbee)



Kód	popis
<b>180014</b>	95 x 120 mm (v x š) LED 4,9 W RGB

### Castor 3



Kód	popis
<b>180013</b>	95 x 100 mm (v x š) LED 2,5 W teplá biela

### Castor 4



Kód	popis
<b>180850</b>	95 x 60 (v x š) LED 3,5 W teplá biela

### Castor 8



Kód	popis
<b>180855</b>	95 x 60 (v x š) LED 8 W teplá biela

### Castor 9



Kód	popis
<b>180856</b>	95 x 60 (v x š) LED 9 W teplá biela

### Kryt na Castor 8, 9



Kód	popis
<b>180857</b>	Kryt na Castor 8, 9

### Quartz



Kód	popis
<b>180024</b>	105 x 88 mm (v x š) LED 1,8 W teplá biela

### Nilus



Kód	popis
<b>180027</b>	135 x 110 (v x š) LED 3,4 W teplá biela

### Avior



Kód	popis
<b>180026</b>	15 x 68 (v x š) LED 16 W teplá biela



Stmievateľné osvetlenie



LEN NA OBJEDNÁVKU

## Juno 2



Kód	popis
<b>180022</b>	85 x 68 mm (v x š) LED 1,5 W teplá biela

## Juno 4

IP65  

Kód	popis
<b>180023</b>	85 x 68 mm (v x š) LED 4 W teplá biela

## Juno Tube

IP65  

Kód	popis
<b>180001</b>	85 x 68 (v x š) LED 4 W teplá biela

## Stojan pre Juno Tube



Kód	popis
<b>180016</b>	Stojan pre Juno Tube

## Xible



Kód	popis
<b>180009</b>	695 x 36 mm (v x š) LED 2 W teplá biela

## Nástenné svetlá Garden Lights



**Palm**

Kód	popis
<b>180011</b>	60 x 100 mm (v x š) LED 1 W teplá biela



**Deimos čierny**



Kód	popis
<b>180276</b>	140 x 140 mm (v x š) LED 1,5 W teplá biela



**Celata**

Kód	popis
<b>180238</b>	380 x 190 mm (v x š) LED 3,5 W teplá biela



**Columba**

Kód	popis
<b>180237</b>	450 x 220 mm (v x š) LED 3,5 W teplá biela



**Boaz**

Kód	popis
<b>180039</b>	107 x 70 mm (v x š) LED 1,8 W teplá biela



**Mauri Black**



Kód	popis
<b>180224</b>	100 x 100 mm (v x š) LED 6 W



Možnosť prepínania:  
teplá / studená biela



Zmena uhlu  
vyžarovania  
nahor a nadol



LEN NA  
OBJEDNÁVKU

Nástenné svetlá Garden Lights

**Gilvus Anthracite**



Kód	popis
<b>180231</b>	92 x 67 mm (v x š) LED 4 W teplá biela

**Gilvus Black**



Kód	popis
<b>180229</b>	92 x 67 mm (v x š) LED 4 W teplá biela

**Gilvus SMART (Zigbee)**



Kód	popis
<b>181036</b>	92 x 67 mm (v x š) LED 5 W RGB

**Sibus Black**



Kód	popis
<b>180232</b>	152 x 67 mm (v x š) LED 4 W teplá biela

**Sitta**



Kód	popis
<b>180236</b>	220 x 120 mm (v x š) LED 3,5 W teplá biela

**Nano**



Kód	popis
<b>180620</b>	90 x 65 mm (v x š) LED 1,8 W teplá biela

**Mats**



Kód	popis
<b>180056</b>	190 x 300 mm (v x š) LED 3,5 W teplá biela

**Ilva**



Kód	popis
<b>180049</b>	90 x 130 mm (v x š) LED 1,8 W teplá biela



Zmena uhlu  
vyžarovania  
nahor a nadol



LEN NA  
OBJEDNÁVKU

## Nástenné svetlá LIGHTPRO

### Polaris



Kód	popis
<b>180576</b>	35 x 145 mm (v x š) LED 6 W teplá biela

### Kuma



Kód	popis
<b>180577</b>	35 x 145 mm (v x š) LED 6 W teplá biela

### Tiga DL



IP67



Kód	popis
<b>180012</b>	88 x 63 mm (v x š) LED 4,2 W teplá biela

### Tiga Corner



Kód	popis
<b>181041</b>	46 x 105 mm (v x š) LED 3,5 W teplá biela

### Tiga Wall



IP67



Kód	popis
<b>181042</b>	75 x 42 mm (v x š) LED 4 W teplá biela

### Rodas



Kód	popis
<b>180786</b>	100 x 20 mm (v x š) LED 3,3 W teplá biela

### Onyx 20



IP67



Kód	popis
<b>180032</b>	33 x 20 mm (v x š) LED 0,3 W teplá biela

### Ixion



Kód	popis
<b>180028</b>	110 x 110 mm (v x š) LED 9 W teplá biela

Bodové svetlá vstavané Garden Lights

**Alpha** biela

IP67  



Kód	popis
<b>180520</b>	46 x 44 mm (v x š) LED 0,5 W biela

**Alpha** teplá biela

IP67  



Kód	popis
<b>180425</b>	46 x 44 mm (v x š) LED 0,5 W teplá biela

**Sirius**

IP67  



Kód	popis
<b>180405</b>	52 x 70 mm (v x š) LED 1 W teplá biela

**Brevus**

IP67  



Kód	popis
<b>180120</b>	52 x 70 mm (v x š) LED 1 W biela

**Larch**

IP67  



Kód	popis
<b>180060</b>	52 x 70 mm (v x š) LED 1 W teplá biela

**Astrum** modrá

IP67  



Kód	popis
<b>180160</b>	28 x 40 mm (v x š) LED 0,3 W modrá

**Astrum**

IP67  



Kód	popis
<b>180145</b>	28 x 40 mm (v x š) LED 0,3 W biela

## Bodové svetlá vstavané Garden Lights

**Birch**

IP67  



Kód popis

**180050** 45 x 40 mm (v x š)  
LED 0,5 W teplá biela

**Leda**

IP67  



Kód popis

**180410** 52 x 70 mm (v x š)  
LED 1 W teplá biela

**Acis**

IP67  



Kód popis

**180037** 20 x 40 mm (v x š)  
LED 0,2 W teplá biela



**Carbo (Elara)** IP67





Kód popis

**180420** 115 x 115 mm (v x š)  
LED 2 W

**Rubum**

IP67  



Kód popis

**180625** 110 x 160 mm (v x š)  
LED 5 W teplá biela



**Rubum SMART (Zigbee)**



IP67  

Kód popis

**181033** 110 x 160 mm (v x š)  
LED 5 W RGB





Možnosť prepínania:  
teplá / studená biela



LEN NA  
OBJEDNÁVKU

Bodové svetlá vstavané LIGHTPRO

**Agate** IP67  



Kód	popis
<b>180585</b>	110 x 160 mm (v x š) LED 2,6 W teplá biela

**Atik R1** IP67  





Kód	popis
<b>180591</b>	135 x 120 mm (v x š) LED 9 W teplá biela

**Atik SMART (Zigbee)**  IP67  





Kód	popis
<b>181049</b>	135 x 120 mm (v x š) LED 4,9 W RGB

**Onyx 30 RA** IP67  





Kód	popis
<b>181044</b>	59 x 45 mm (v x š) LED 0,5 W teplá biela

**Onyx 30 RS** IP67  





Kód	popis
<b>181043</b>	59 x 45 mm (v x š) LED 0,5 W teplá biela

**Onyx 60 RA** IP67  





Kód	popis
<b>181045</b>	59 x 75 mm (v x š) LED 1 W teplá biela

**Onyx 60 RS** IP67  



Kód	popis
<b>181046</b>	59 x 75 mm (v x š) LED 1 W teplá biela

**Onyx 90 RA** IP67  



Kód	popis
<b>181048</b>	59 x 105 mm (v x š) LED 2 W teplá biela

**Onyx 90 RS** IP67  



Kód	popis
<b>181047</b>	59 x 105 mm (v x š) LED 2 W teplá biela

**Nomia** IP67  



Kód	popis
<b>180033</b>	125 x 90 mm (v x š) LED 3 W teplá biela

## Dekoračné svetlá Garden Lights



**Round 30 SMART  
(Zigbee)**



Kód	popis
<b>181051</b>	Ø 300 mm LED 2 W RGB

**Round 40 SMART  
(Zigbee)**



Kód	popis
<b>181052</b>	Ø 400 mm LED 3 W RGB

**Round 50 SMART  
(Zigbee)**



Kód	popis
<b>181053</b>	Ø 500 mm LED 4 W RGB

### Partylights



Kód	popis
<b>180057</b>	95 x 50 mm (v x š) LED 8 W teplá biela

### Linea all seasons reťaz



Kód	popis
<b>180051</b>	30 x 6 mm (v x š) LED 4,5 W teplá biela

## Dekoračné svetlá LIGHTPRO

### LED pás 15 m

IP67



Kód	popis
<b>1809990</b>	15 x 10 mm (v x š) LED 2,2 W teplá biela

### Konektor pre LED pás



Kód	popis
<b>220L</b>	Konektor pre LED pás

### Spona na LED pás



Kód	popis
<b>181050</b>	Spona na LED pás



Kód	popis
<b>180985</b>	<b>Transformátor 24 W</b>



Kód	popis
<b>1809902</b>	<b>Transformátor 60 W</b>



Kód	popis
<b>1809802</b>	<b>Transformátor 150 W</b>



Kód	popis
<b>180775</b>	<b>Káblová rozbočka SPT-2W</b>



Kód	popis
<b>180780</b>	<b>Sada DO + prijímač max. 150 W</b>



Kód	popis
<b>180770</b>	<b>Prijímač vonkajší max. 150 W</b>



Kód	popis
<b>180750</b>	<b>Predlžovací kábel SPT-1W 6 m, max. 120 W</b>



Kód	popis
<b>180765</b>	<b>Pohybový senzor max. 60 W</b>



Kód	popis
<b>180530</b>	<b>Súmrakový prog. senzor max. 150 W</b>



Kód	popis
<b>180984</b>	<b>Transformátor 100 W Touch + timer</b>



Kód	popis
<b>180987</b>	<b>Transformátor 150 W Touch + timer</b>



Kód	popis
<b>180747</b>	<b>Predlžovací kábel 3 m SPT-2</b>



Kód	popis
<b>180746</b>	<b>Predlžovací kábel 1 m SPT-2</b>



Kód	popis
<b>180983</b>	<b>Predlžovací kábel pre súmr. senzor 6 m, transformátor + timer 60 W</b>



Kód	popis
<b>180736</b>	<b>Hlavný kábel 50 m max. 150 W</b>



Kód	popis
<b>180738</b>	<b>Hlavný kábel 200 m - režeme (bm) max. 150 W</b>



Kód	popis
<b>180739</b>	<b>Hlavný kábel 200 m max. 150 W</b>



Kód	popis
<b>180757</b>	<b>Odbočka typ M-M</b>



Kód	popis
<b>180756</b>	<b>Odbočka typ F</b>

Príslušenstvo LIGHTPRO



IP68

Kód	popis
<b>231A150</b>	<b>Kryt na transformátor</b>

Kód	popis
<b>181054</b>	<b>Kryt konektora IP 68</b>

Príslušenstvo LIGHTPRO SMART (Zigbee)



Kód	popis
<b>180066</b>	<b>Ovládač Switch Smart (Wifi)</b>

Kód	popis
<b>180036</b>	<b>Gateway Smart (Wifi, Zigbee)</b>



Kód	popis
<b>180034</b>	<b>Pohybový senzor Smart (Zigbee)</b>

Kód	popis
<b>180068</b>	<b>Kamera Smart (Wifi)</b>



Kód	popis
<b>180542</b>	<b>Svetelný zdroj MR16 SMART (Zigbee) RGB</b>

**Náhradné svetelné zdroje**  
Informujte sa o type a dostupnosti potrebných náhradných dielov u predajcu.

**Mramor biely**



Kód	frakcia	balenie
<b>919003</b>	8/16 mm	25 kg
<b>919004</b>	8/16 mm	BB
<b>919002</b>	16/32 mm	25 kg
<b>919001</b>	16/32 mm	BB

**Gneis „kamenná kôra“**



Kód	frakcia	balenie
<b>89107</b>	8/16 mm	25 kg
<b>89102</b>	8/16 mm	BB
<b>89101</b>	11/32 mm	25 kg
<b>89104</b>	11/32 mm	BB
<b>89105</b>	32/63 mm	25 kg
<b>89103</b>	32/63 mm	BB

**Šedá kamenná štiepka**



Kód	frakcia	balenie
<b>92069</b>	30/60 mm	25 kg
<b>92086</b>	30/60 mm	BB

**Žula biela**



Kód	frakcia	balenie
<b>92031</b>	8/16 mm	25 kg
<b>92033</b>	8/16 mm	BB
<b>92035</b>	16/22 mm	25 kg
<b>92034</b>	16/22 mm	BB

**Fialová štiepka**



Kód	frakcia	balenie
<b>92056</b>	30/60 mm	25 kg
<b>92063</b>	30/60 mm	BB

**Kamenná štiepka zlatá**



Kód	frakcia	balenie
<b>92059</b>	16/32 mm	25 kg
<b>92058</b>	16/32 mm	BB

**Vápenec žltobiely**

Kód	frakcia	balenie
<b>87166</b>	8/16 mm	25 kg
<b>87165</b>	8/16 mm	BB

**Vápenec ružový**

Kód	frakcia	balenie
<b>87186</b>	8/16 mm	25 kg
<b>87184</b>	8/16 mm	BB

**Rosso Verona**

Kód	frakcia	balenie
<b>91998</b>	16/22 mm	25 kg
<b>91997</b>	16/22 mm	BB

**Giallo Mori**

Kód	frakcia	balenie
<b>94021</b>	16/22 mm	25 kg
<b>91992</b>	16/22 mm	BB

**Bardiglio - Ice Blue**

Kód	frakcia	balenie
<b>91216</b>	16/22 mm	25 kg

**Nero Ebano**

Kód	frakcia	balenie
<b>94023</b>	16/22 mm	25 kg
<b>89868</b>	16/22 mm	BB

**Serpentinit**

Kód	frakcia	balenie
<b>89141</b>	16/22 mm	25 kg

**Verde Alpi**

Kód	frakcia	balenie
<b>94022</b>	16/22 mm	25 kg

**Travertine Light**



Kód	frakcia	balenie
<b>89552</b>	16/32 mm	BB
<b>89553</b>	32/63 mm	BB

**Atlas Red**



Kód	frakcia	balenie
<b>91859</b>	20/28 mm	BB

**Čadič čierny**



Kód	frakcia	balenie
<b>89408</b>	16/32 mm	BB

**Amfibolit**



Kód	frakcia	balenie
<b>89139</b>	11/22 mm	BB

**Piesok do pieskoviska**



Kód	frakcia	balenie
<b>94014</b>	0/2 mm	25 kg

**Lávový kameň Lapillo**



Kód	frakcia	balenie
<b>91861</b>	10/20 mm	18 kg
<b>91868</b>	10/20 mm	BB
<b>8046</b>	10/16 mm	33 l
<b>8047</b>	10/16 mm	BB
<b>8033</b>	20/70 mm	33 l
<b>8037</b>	20/70 mm	BB

**Pemza**



Kód	frakcia	balenie
<b>8054</b>	7/14 mm	BB
<b>8056</b>	7/14 mm	50 l

**Zeolit**



Kód	frakcia	balenie
<b>89022</b>	4/8 mm	25 kg

**Thassos biely mramor**

Kód	frakcia	balenie
<b>91900</b>	10/20 mm	25 kg
<b>91901</b>	10/20 mm	BB
<b>91902</b>	20/40 mm	25 kg
<b>91903</b>	20/40 mm	BB
<b>94011</b>	40/80 mm	25 kg
<b>91905</b>	40/80 mm	BB

**Atlas Green**

Kód	frakcia	balenie
<b>91984</b>	10/20 mm	25 kg
<b>91977</b>	10/20 mm	BB
<b>91986</b>	20/40 mm	25 kg
<b>91978</b>	20/40 mm	BB

**Atlas Red**

Kód	frakcia	balenie
<b>91980</b>	10/20 mm	25 kg
<b>91974</b>	10/20 mm	BB
<b>91982</b>	20/40 mm	25 kg
<b>91975</b>	20/40 mm	BB

**Botticino**

Kód	frakcia	balenie
<b>89853</b>	15/25 mm	25 kg
<b>89854</b>	15/25 mm	BB
<b>89852</b>	20/50 mm	25 kg

**Rosso Verona**

Kód	frakcia	balenie
<b>89850</b>	15/25 mm	25 kg
<b>89859</b>	15/25 mm	BB
<b>89851</b>	20/50 mm	25 kg

**Giallo Mori**

Kód	frakcia	balenie
<b>89830</b>	15/25 mm	25 kg
<b>89831</b>	15/25 mm	BB

Okruhliaky

**Bardiglio - Ice Blue**



Kód	frakcia	balenie
<b>91995</b>	15/25 mm	25 kg
<b>89861</b>	15/25 mm	BB
<b>91996</b>	20/50 mm	25 kg

**Nero Ebano**



Kód	frakcia	balenie
<b>89840</b>	15/25 mm	25 kg
<b>89838</b>	15/25 mm	BB
<b>89843</b>	20/50 mm	25 kg
<b>89844</b>	20/50 mm	BB

**Verde Alpi**



Kód	frakcia	balenie
<b>89855</b>	15/25 mm	25 kg
<b>89856</b>	20/50 mm	25 kg

**Žula okruhliak**



Kód	frakcia	balenie
<b>89400</b>	30/70 mm	BB
<b>89402</b>	50/100 mm	BB

**Firde Cristallo**



Kód	frakcia	balenie
<b>92103</b>	10/20 mm	25 kg
<b>92101</b>	10/20 mm	BB
<b>92104</b>	20/40 mm	25 kg
<b>92102</b>	20/40 mm	BB

**Silver flat**



Kód	frakcia	balenie
<b>920431</b>	40/60 mm	25 kg
<b>920432</b>	40/60 mm	BB

**Granite**

Kód	frakcia	balenie
<b>91858</b>	20/40 mm	25 kg
<b>91848</b>	20/40 mm	BB
<b>92106</b>	40/60 mm	25 kg
<b>91923</b>	40/60 mm	BB

**Stripe Onyx**

Kód	frakcia	balenie
<b>92105</b>	20/40 mm	25 kg
<b>919071</b>	20/40 mm	BB
<b>919072</b>	40/60 mm	BB

**Praný štrk**

Kód	frakcia	balenie
<b>89425</b>	4/8 mm	BB
<b>89426</b>	8/16 mm	BB
<b>89431</b>	16/32 mm	BB

**Granite Balls**

Kód	frakcia	balenie
<b>91972</b>	40/60 mm	25 kg
<b>91866</b>	40/60 mm	kôš

**Rainbow**

Kód	frakcia	balenie
<b>91963</b>	10/20 mm	25 kg
<b>91896</b>	30/60 mm	25 kg

**Black Stone**

Kód	frakcia	balenie
<b>92125</b>	20/40 mm	25 kg
<b>92123</b>	20/40 mm	BB

**Leilac**

Kód	frakcia	balenie
<b>92124</b>	20/40 mm	25 kg
<b>92122</b>	20/40 mm	BB

**Gneis kusový**

Kód	frakcia	balenie
<b>89096</b>	10/50 cm	BB

**Vápenec „Chorvátsky“ dierový žltohnedý**

Kód	frakcia	balenie
<b>88965</b>	10/50 cm	BB

**Žula okruhliak**

Kód	frakcia	balenie
<b>91877</b>	10/30 cm	BB
<b>89730</b>	20/40 cm	BB
<b>91881</b>	30/50 cm	BB

**Nero Ebano**

Kód	frakcia	balenie
<b>94072</b>	20/40 cm	kôš

**Travertine Light**

Kód	frakcia	balenie
<b>89554</b>	20/40 cm	kôš

**Mramor biely kusový**

Kód	frakcia	balenie
<b>94012</b>	10/50 cm	kôš

**Stripe Onyx**

Kód	frakcia	balenie
<b>91830</b>	20/40 cm	kôš

**Black Angel**

Kód	frakcia	balenie
<b>91820</b>	30/50 cm	kôš

**Green Angel omielané**

Kód	frakcia	balenie
<b>91810</b>	10/20 cm	kôš
<b>81838</b>	20/40 cm	kôš

**Black Angel omielané**

Kód	frakcia	balenie
<b>91800</b>	10/20 cm	kôš
<b>91837</b>	20/40 cm	kôš

**Stripe Onyx omielané**

Kód	frakcia	balenie
<b>91840</b>	20/40 cm	kôš

**Granite Balls omielané**

Kód	frakcia	balenie
<b>91809</b>	20/30 cm	kôš

**Red Spaghetti**

Kód	frakcia	balenie
<b>91814</b>	20/40 cm	kôš

**Red Lava**

Kód	frakcia	balenie
<b>91812</b>	20/40 cm	kôš

**Moonstone**

Kód	frakcia	balenie
<b>88970</b>	20/40 cm	kôš

**Púštna ruža**

Kód	frakcia	balenie
<b>91645</b>	rôzna	

**Pure White**

Kód	frakcia	balenie
<b>93071</b>	10/30 cm	kôš

**Vápenec dierový Aris**

Kód	frakcia	balenie
<b>91685</b>	20/40 cm	kôš

**Serpentinit**

Kód	frakcia	balenie
<b>89143</b>	30/50 cm	kôš

**Andezit A2 murovací**

Kód	frakcia	balenie
<b>87450</b>	2/4 cm	paleta
<b>87471</b>	4/7 cm	paleta
<b>87452</b>	7/15 cm	paleta

**Gneis murovací**

Kód	frakcia	balenie
<b>89108</b>	6/10 cm	paleta

**Tufový blok**

Kód	frakcia	balenie
<b>8028</b>	37 x 11 x 11 cm	paleta
<b>8029</b>	37 x 20 x 11 cm	paleta

**Desert Black**

Kód	frakcia	balenie
<b>91346</b>	40 - 60 x 35 - 40 x 3 - 4 cm	drevený kôš

**Kandla Grey**

Kód	frakcia	balenie
<b>91347</b>	40 - 60 x 35 - 40 x 3 - 4 cm	drevený kôš

**DYB - Desert Yellow Brown**

Kód	frakcia	balenie
<b>91348</b>	40 - 60 x 35 - 40 x 3 - 4 cm	drevený kôš

**Modak**

Kód	frakcia	balenie
<b>91343</b>	40 - 60 x 35 - 40 x 3 - 4 cm	drevený kôš

**Mint**

Kód	frakcia	balenie
<b>91341</b>	40 - 60 x 35 - 40 x 3 - 4 cm	drevený kôš

**Mandana**

Kód	frakcia	balenie
<b>91344</b>	40 - 60 x 35 - 40 x 3 - 4 cm	drevený kôš

**Raveena**

Kód	frakcia	balenie
<b>91345</b>	40 - 60 x 35 - 40 x 3 - 4 cm	drevený kôš

**Bridlica tmavošedá**

Kód	frakcia	balenie
<b>92032</b>	40 - 80 x 4 - 7 cm	paleta

Šlapáky

Vápenec B4 „Chorvátsky“



Kód	frakcia	balenie
<b>91670</b>	40 - 80 x 4 - 7 cm	paleta

Andezit A4



Kód	frakcia	balenie
<b>89782</b>	40 - 80 x 3 - 6 cm	paleta
<b>89783</b>	40 - 80 x 6 - 11 cm	paleta

Dlažby, kocky, palisády

Autumn Grey



Kód	frakcia	balenie
<b>91552</b>	40 x 40 cm	drevený kôš
<b>91557</b>	60 x 60 cm	drevený kôš
<b>92171</b>	60 x 90 cm	drevený kôš

Modak



Kód	frakcia	balenie
<b>91562</b>	20 x 20 cm	drevený kôš
<b>91553</b>	40 x 40 cm	drevený kôš
<b>91563</b>	60 x 60 cm	drevený kôš
<b>92172</b>	60 x 90 cm	drevený kôš

Mint



Kód	frakcia	balenie
<b>91551</b>	40 x 40 cm	drevený kôš
<b>91555</b>	60 x 60 cm	drevený kôš
<b>92173</b>	60 x 90 cm	drevený kôš

Schodiskový blok Desert Black



Kód	frakcia	balenie
<b>92273</b>	100 x 35 x 15 cm	ks

## Dlažby, kocky, palisády

## Schodiskový blok Modak



Kód	frakcia	balenie
<b>92271</b>	100 x 35 x 15 cm	ks

## Schodiskový blok Autumn Grey



Kód	frakcia	balenie
<b>92272</b>	100 x 35 x 15 cm	ks

## Vápenec B4 „Chorvátsky“



Kód	frakcia	balenie
<b>91660</b>	15 - 40 x 4 - 7 cm	paleta

## Andezit A4



Kód	frakcia	balenie
<b>87464</b>	15 - 40 x 3 - 5 cm	paleta
<b>87472</b>	15 - 40 x 5 - 8 cm	paleta

## Bridlicová platňa čierna



Kód	frakcia	balenie
<b>92052</b>	100 x 50 x 4 - 6 cm	paleta

## Bridlicová palisáda čierna



Kód	frakcia	balenie
<b>92061</b>	100 x 10 x 6 - 10 cm	paleta

## Žula palisáda



Kód	frakcia	balenie
<b>92037</b>	100 x 10 x 10 cm	paleta
<b>92038</b>	150 x 12 x 12 cm	paleta

## Žula kocka



Kód	frakcia	balenie
<b>89749</b>	5 x 6 cm	BB
<b>92036</b>	8 x 10 cm	BB
<b>88180</b>	15 x 17 cm	BB

**Dekoračné kamenné doplnky**

**Kamenné stoly, lavice a mosty**



**Kamenné fontány a vodné prvky**



## Dekoračné kamenné doplnky

## Kamenné gule a lampy



## Kamenné zvieratká a napájadlá





Spoločnosť T-TAKÁCS, s.r.o. je váš spoľahlivý partner v oblasti záhradnej a krajinnej tvorby, profesionálneho pestovania, automatických závlhových systémov, bazénovej techniky, čerpacej technológie a stavby jazier. Ponúkame široký sortiment a komplexné služby pre živnostníkov a firmy.

Disponujeme skladovými zásobami v širokej škále produktov.

Ponúkame produkty z celého sveta. Výrobky európskych, amerických výrobcov a aj kvalitné, cenovo dostupné produkty od výrobcov z Ázie.



## SLOVENSKO

**T - TAKÁCS, s.r.o.**  
[www.takacs.sk](http://www.takacs.sk)

## ČESKO

**DOLTAK s.r.o.**  
[www.doltak.cz](http://www.doltak.cz)

## MAĎARSKO

**T - TAKÁCS Kft.**  
[www.ttakacs.hu](http://www.ttakacs.hu)





**T - TAKÁCS, s.r.o.**  
Hlavná 151  
900 29 Nová Dedinka



+421 2 402 080 20  
[info@takacs.sk](mailto:info@takacs.sk)  
[www.takacs.sk](http://www.takacs.sk)

**T.TAKÁCS**